

# LEAP CONNECT

## Practice Test Reference Materials

English Language Arts  
Grade 3

Reference Materials and Writing Stimuli include required graphics that are to be presented to the student during the administration of LEAP Connect ELA Assessment. Refer to the *Directions for Test Administration (DTA)* for detailed instructions.

### **Session 1**

---

*Picture 1, "Bird Feeder Ingredients List" (Items 1-4)*

*"Feeding Birds" Answer Options (Items 1 – 4)*

*"The Gift of Giving" Answer Options (Items 5 – 10)*

*"A Playground for All" Answer Options (Items 11 – 16)*

### **Session 2**

---

*"Working Together for Mom" Answer Options (Items 17 – 22)*

### **Session 3**

---

*Answer Options (Items 23-26)*

*Writing Stimulus 1, "A Trip to the Zoo" (Items 27-32)*

*Answer Options (Items 27-32)*

### **Session 4**

---

*Writing Stimulus 2, "For Great Grandma" (Cards 1a–8a)*

# Session 1

Picture 1, "Bird Feeder Ingredients List" (Items 1-4)

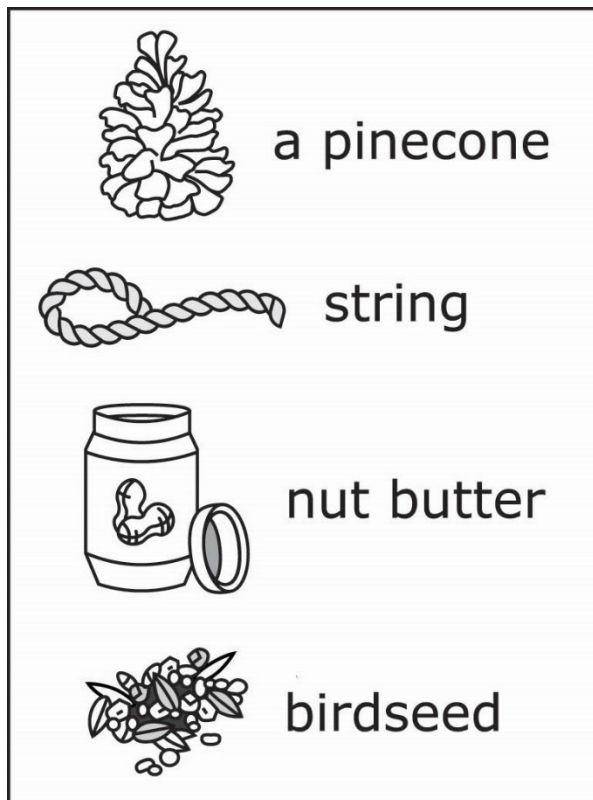

Session 1 – Item 1 Answer Options

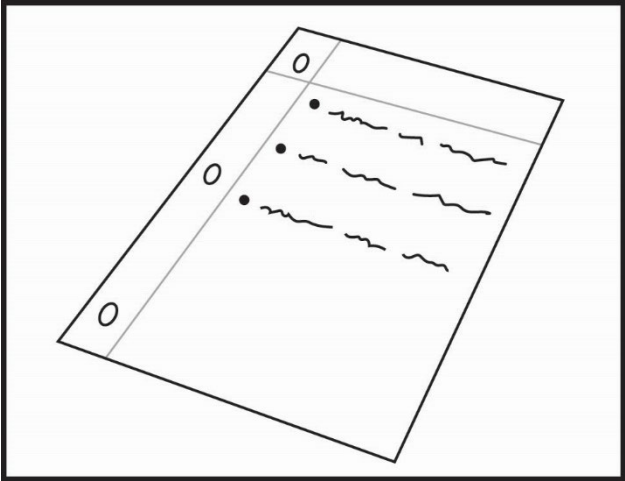

A. a list of things you need to have

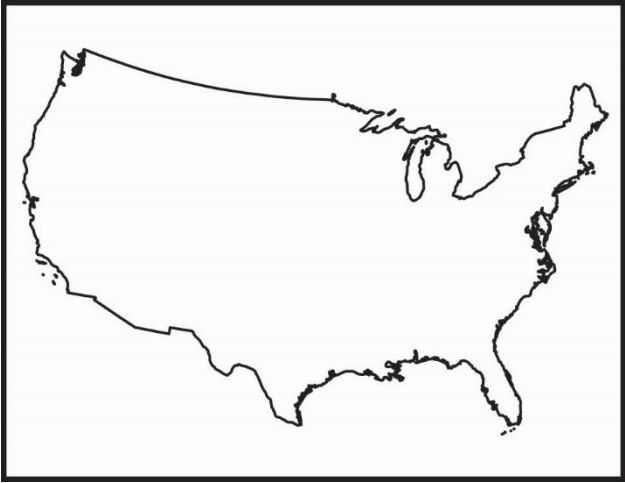

B. a map of where you need to travel

**Session 1 – Item 2 Answer Options**

A. a caption

B. a heading

Session 1 – Item 3 Answer Options

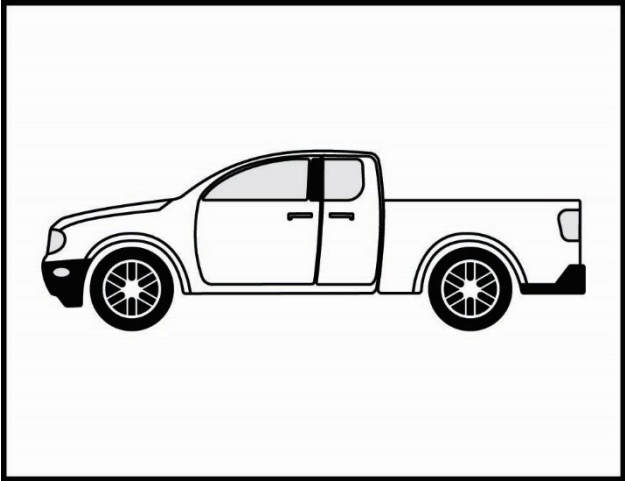

A.

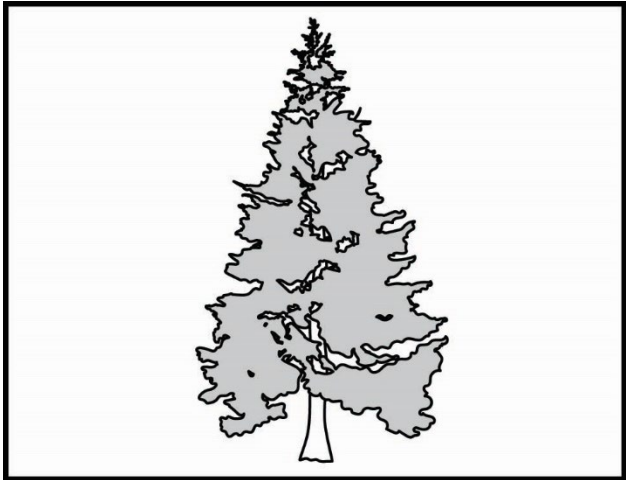

B.

Session 1 – Item 4 Answer Options

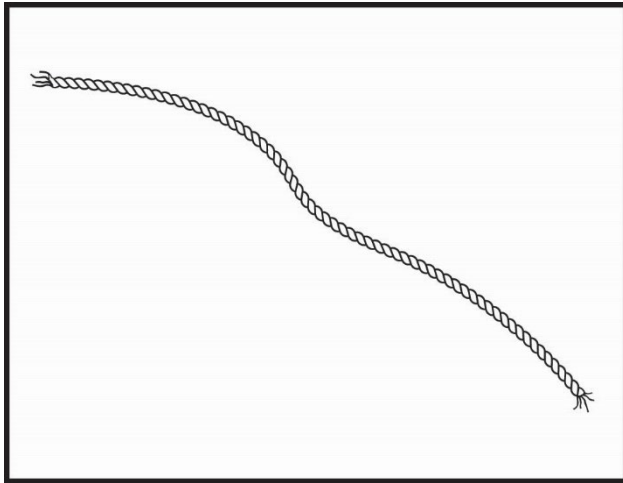

A. a thin cord

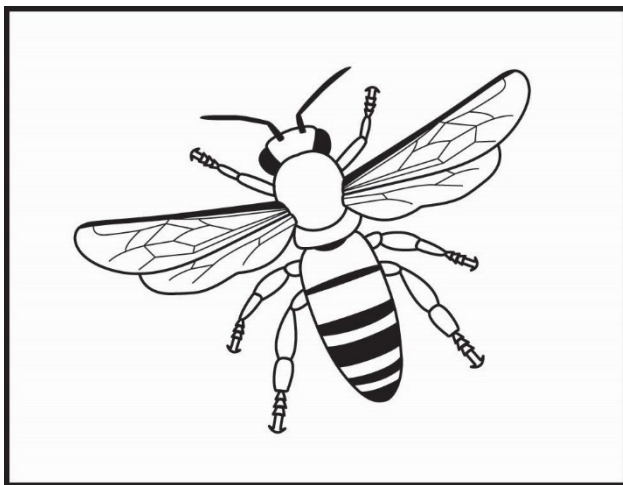

B. a kind of bee



Session 1 – Item 5 Answer Options



A. There are many kinds of toys.

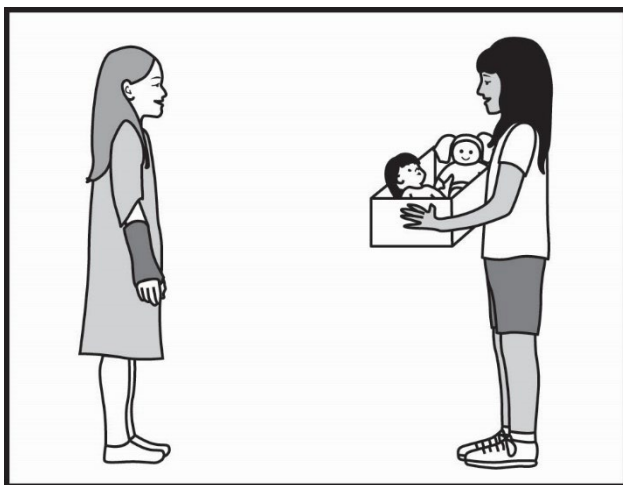

B. Sharing with others feels good.

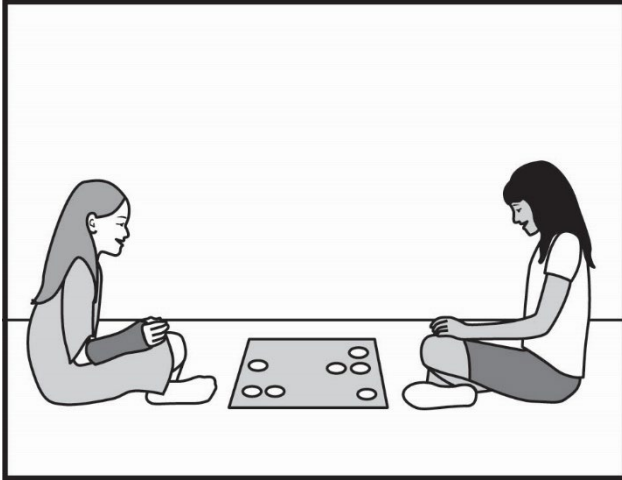

C. Girls like to play games together.

**Session 1 – Item 6 Answer Options**

- A. She does not have enough room to put them away.
  
  
  
  
  
  
  
  
  
  
- B. She does not like the games and stuffed animals she has.
  
  
  
  
  
  
  
  
  
  
- C. She does not want her mom to help her clean up her room.

**Session 1 – Item 7 Answer Options**

A. They just met.

B. They are only visiting.

C. The pieces are missing.

**Session 1 – Item 8 Answer Options**

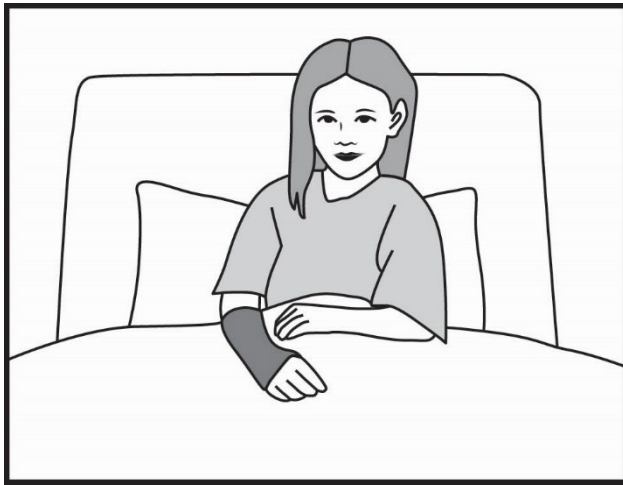

A. The girl in the playroom is staying at the hospital.

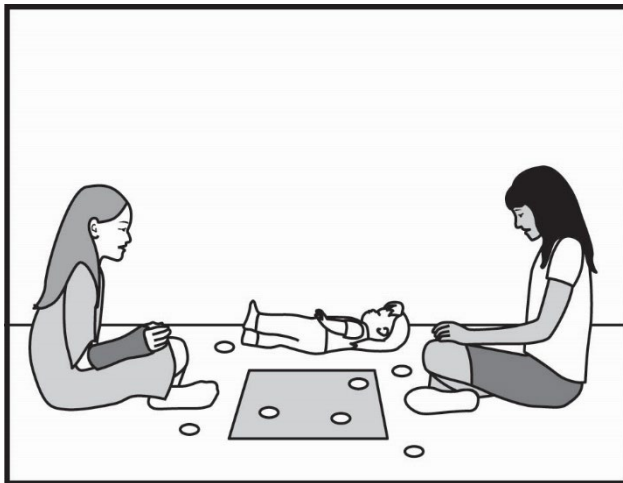

B. There are hardly any toys for the girls to play with.

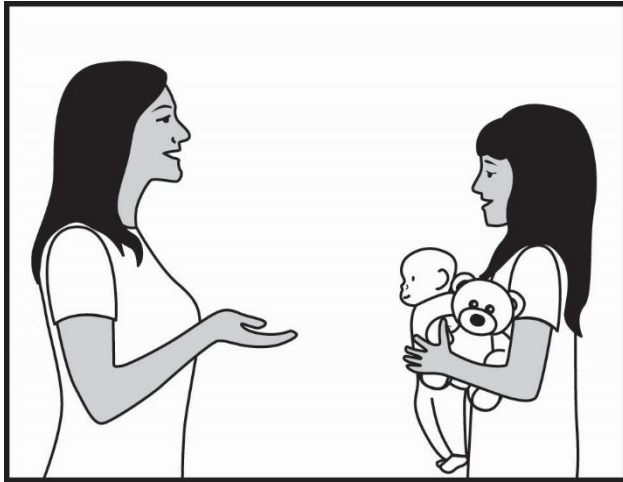

- C. Her mom has an idea to help her find space for her toys.

**Session 1 – Item 9 Answer Options**

A. to have a place for her games

B. to make room for more toys

C. to give to the children’s hospital

Session 1 – Item 10 Answer Options

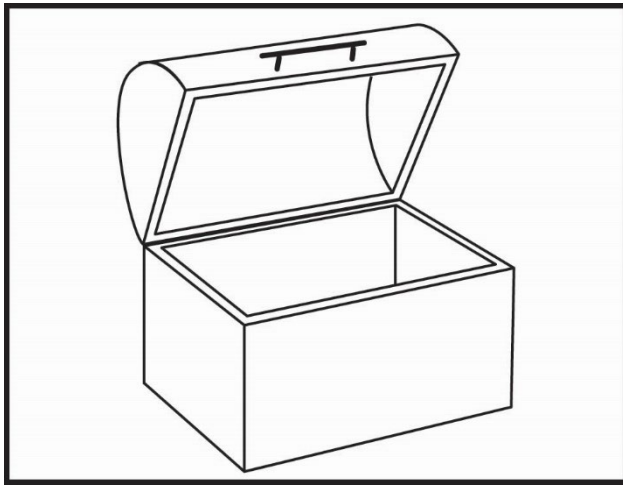

A. a place to keep things

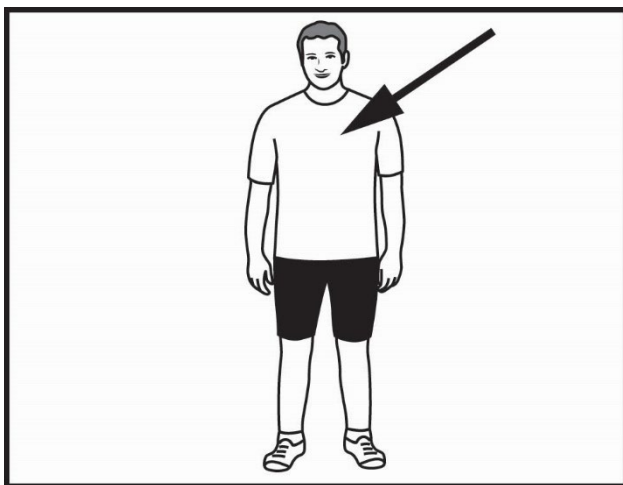

B. a part of the body



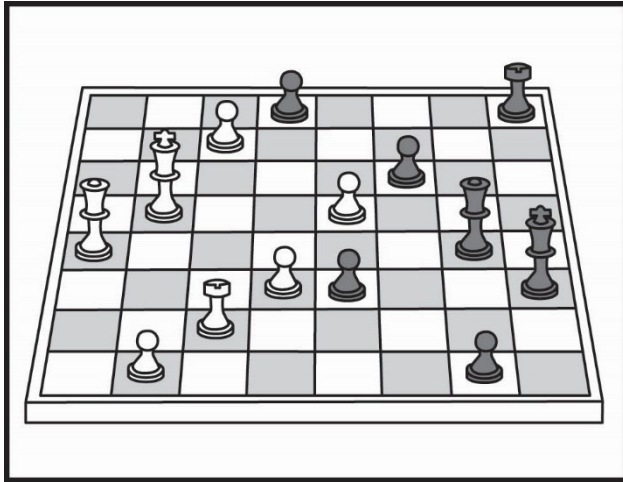

C. a gameboard

Session 1 – Item 11 Answer Options



A. a wheelchair

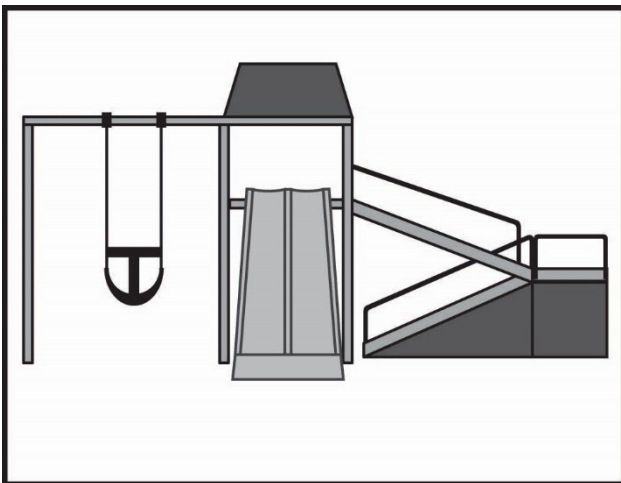

B. a special playground



C. a birthday party

Session 1 – Item 12 Answer Options

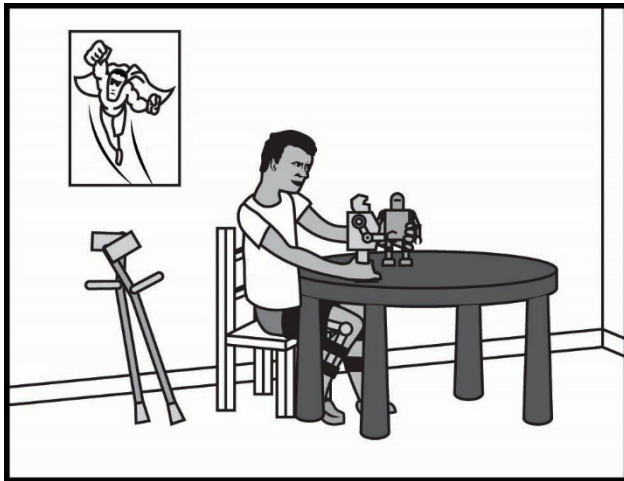

A. "They can play with their friends."

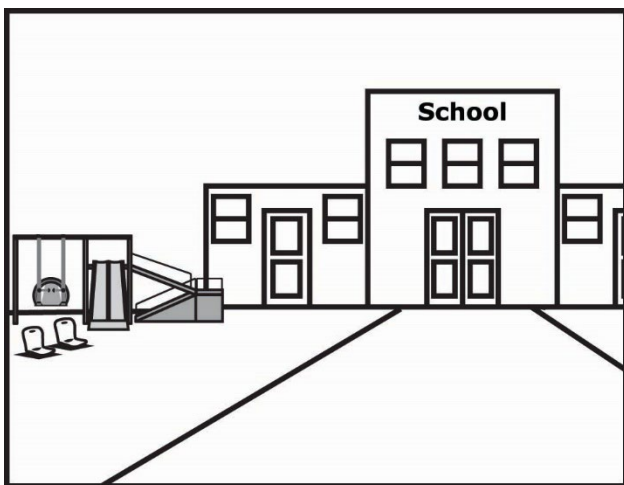

B. "My school has a playground."

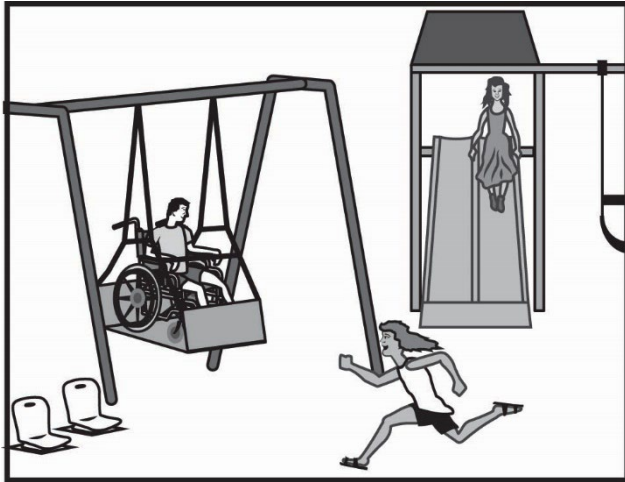

- C. "The playground has different things so all children can play."

Session 1 – Item 13 Answer Options



A. with a rope

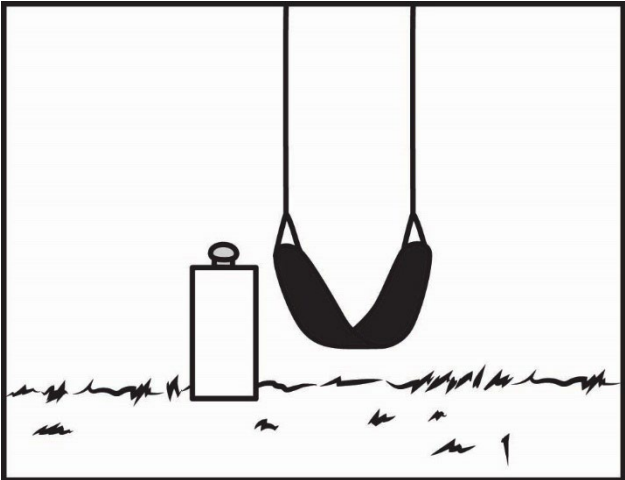

B. with a button

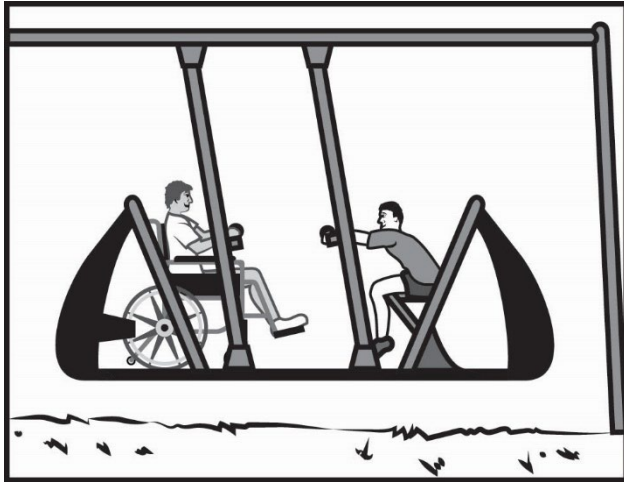

C. with their arms

Session 1 – Item 14 Answer Options



A. How to use a slide.

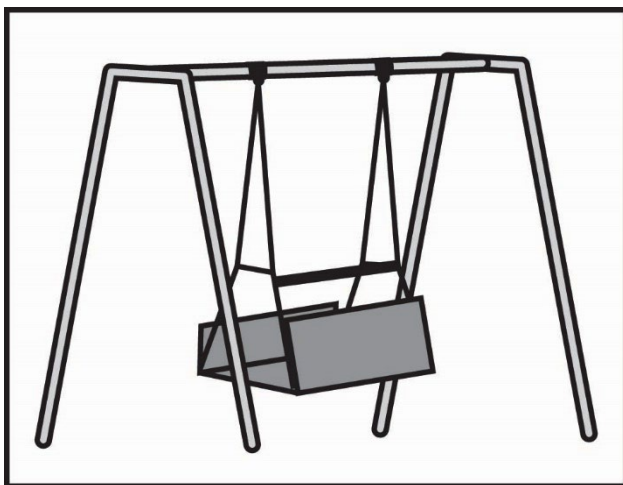

B. How to use a swing for wheelchairs.



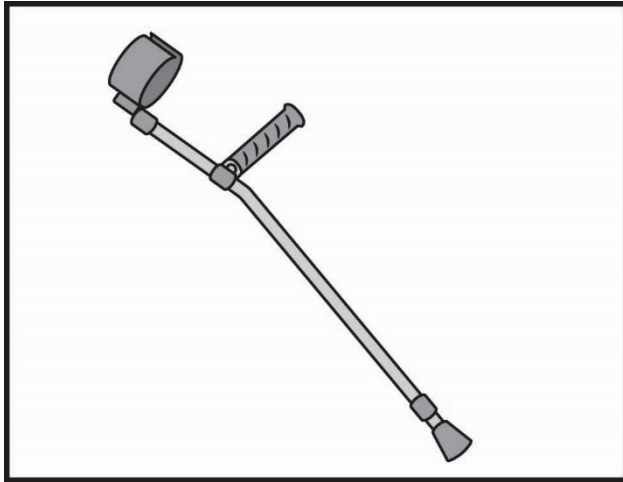

C. How to use a crutch to help someone walk.

**Session 1 – Item 15 Answer Options**

A. how to use the playground

B. what this part of the text is about

C. the name of the playground where the children play

**Session 1 – Item 16 Answer Options**

A. to show what is on her head

B. to show the playground

C. to show the time

# Session 2

Session 2 – Item 17 Answer Options

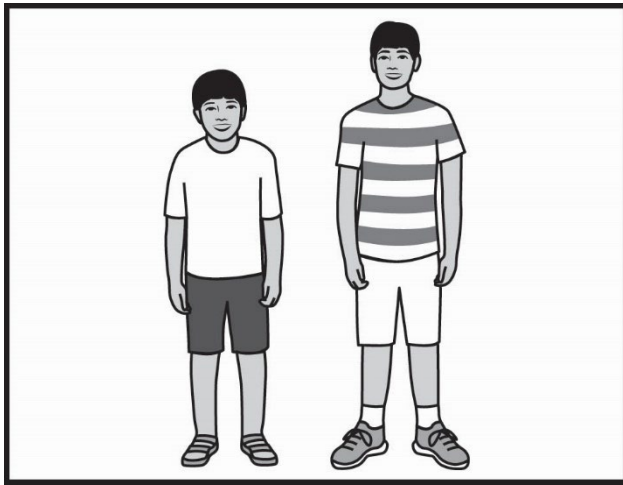

A. Freddy and Jerry are brothers.

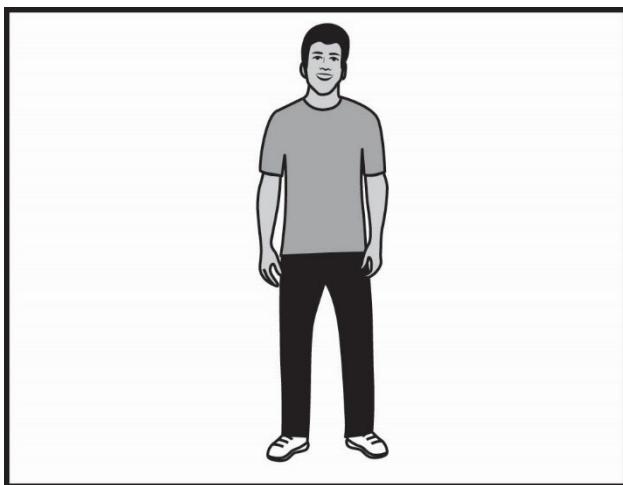

B. Freddy and Jerry have a cousin named Leo.



C. Freddy and Jerry want to do something for their mom.

Session 2 – Item 18 Answer Options

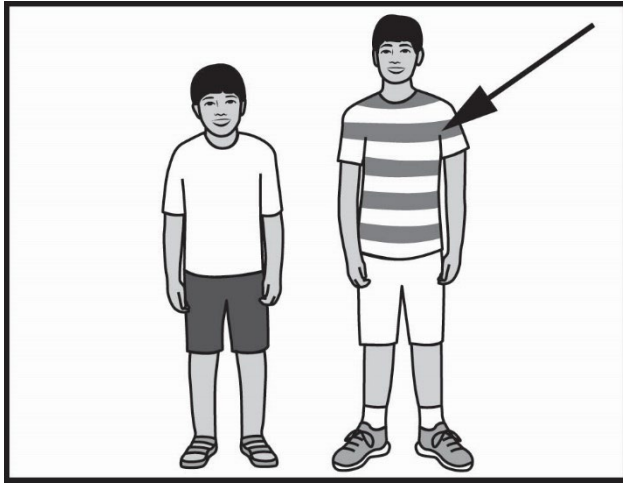

A. Freddy is older than Jerry.



B. Freddy and Jerry clean their room.

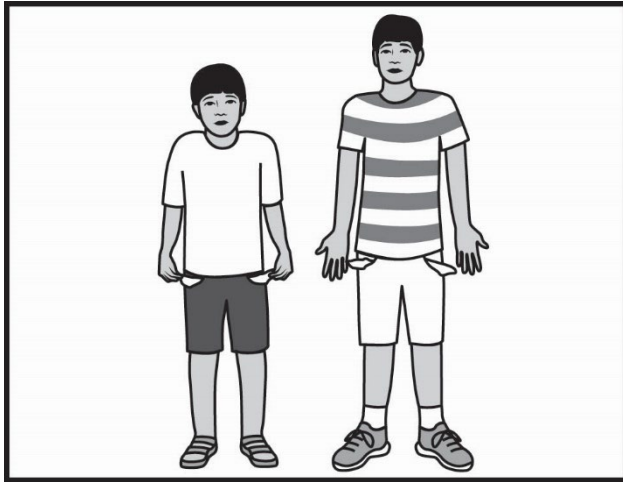

C. Freddy and Jerry have no money for a gift.



Session 2 – Item 19 Answer Options

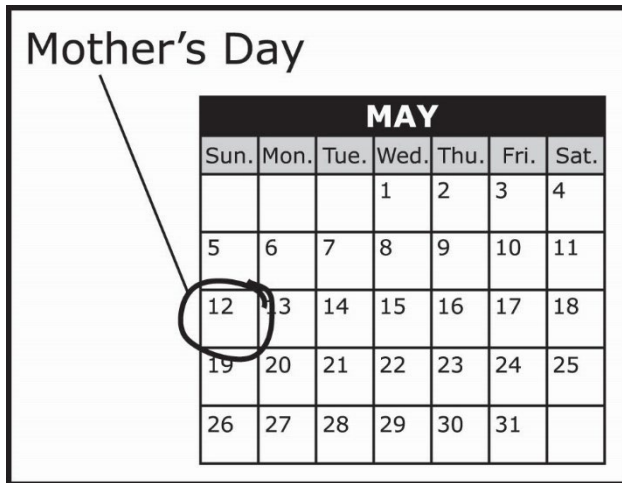

A. As a Mother's Day gift for their mom.

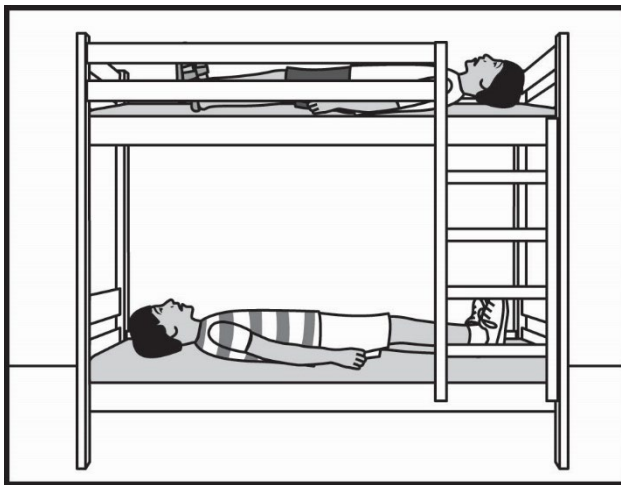

B. They are grounded and cannot play.



C. Their dad told them to clean their room.

Session 2 – Item 20 Answer Options

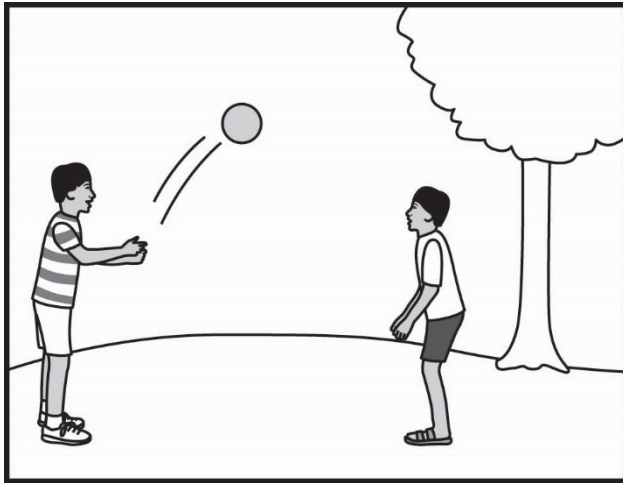

A. They like doing things together.



B. Their mom always asks them to.

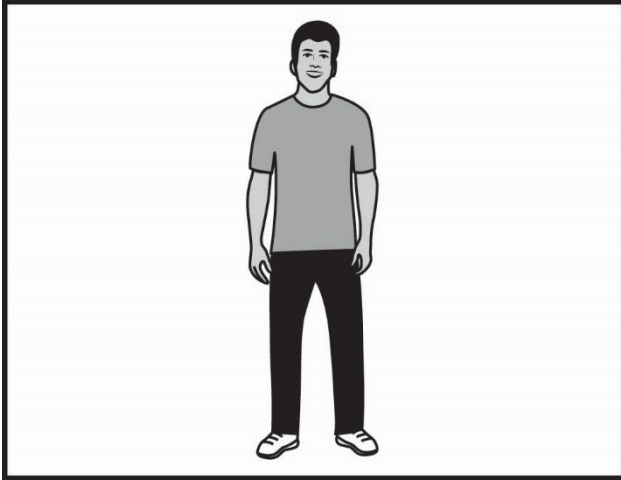

C. Their cousin Leo is their favorite cousin.

Session 2 – Item 21 Answer Options

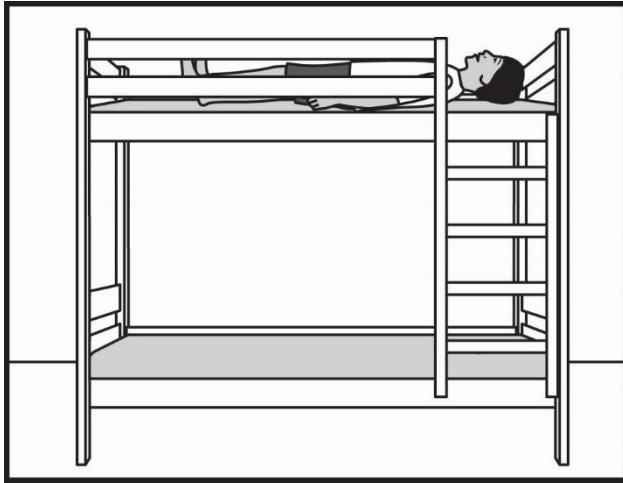

A. He lays on the bed.

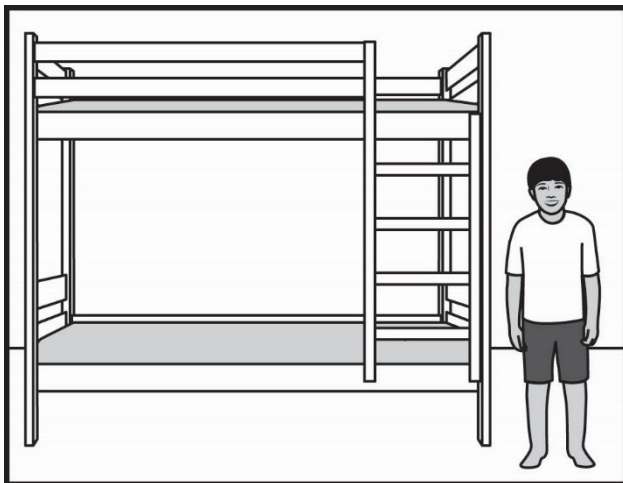

B. He jumps down.



C. He puts away his shoes.

Session 2 – Item 22 Answer Options

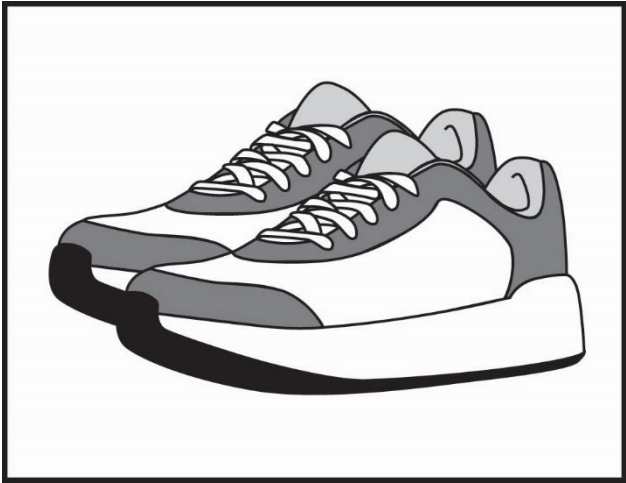

A. A shoe



B. A chore

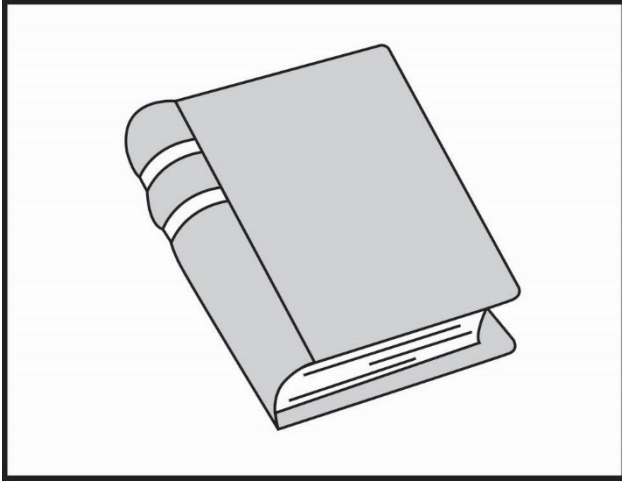

C. A book



# Session 3

**Session 3 – Item 23 Answer Options**

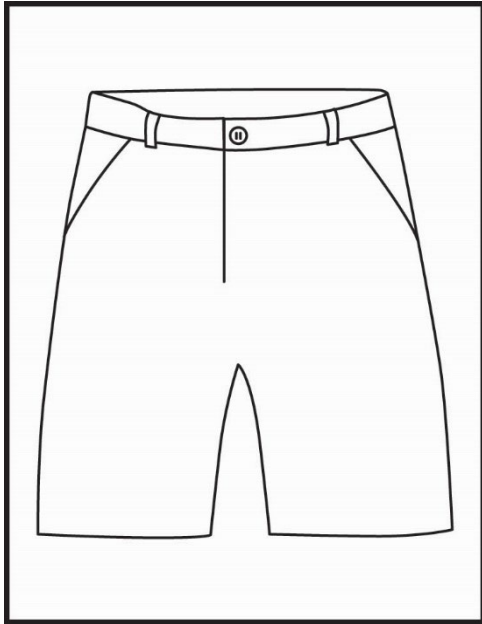

A. Wear shorts on hot days.

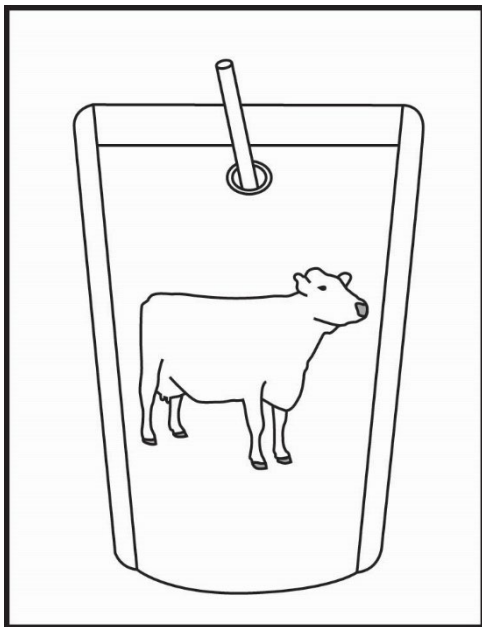

B. Drink milk for lunch.

**Session 3 – Item 24 Answer Options**

A. Baseball is a team sport.

B. Many animals live outside.

C. Doctors take care of people.

**Session 3 – Item 25 Answer Options**

A. sizes of food

B. colors of food

C. kinds of food

Session 3 – Item 26 Answer Options

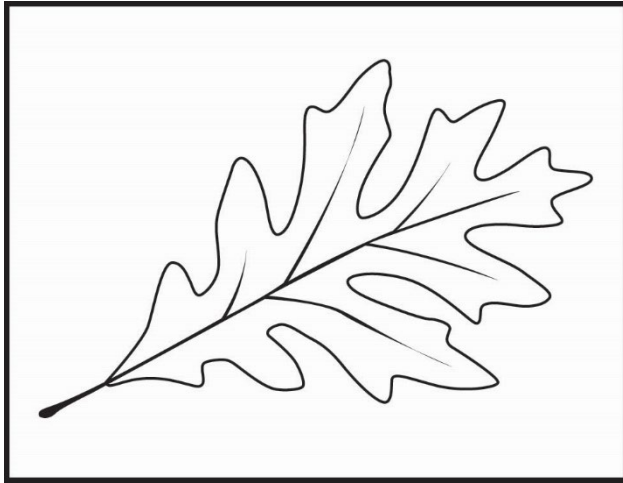

A. a drawing of a leaf

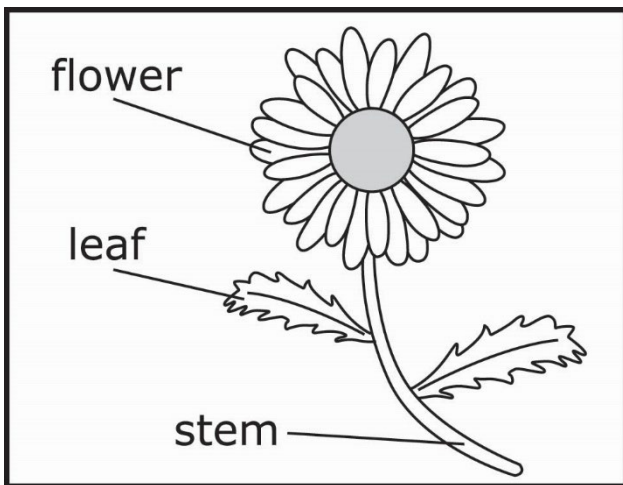

B. a diagram of a flower

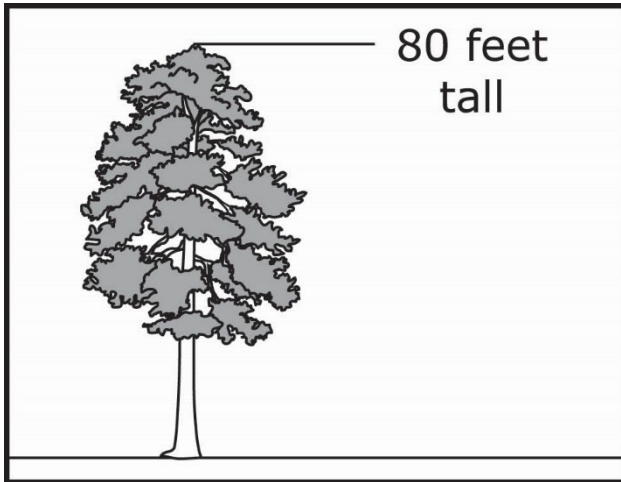

C. a graph of a tree's height

**Writing Stimuli 1, “A Trip to the Zoo” (Items 27-32)**

Noah wants to learn about animals. Noah is going to the zoo today. First, Noah visits the giraffes. Next, Noah watches the penguins. The penguins are playing. By the end, Noah has seen lots of animals at the zoo.

Session 3 – Item 27 Answer Options

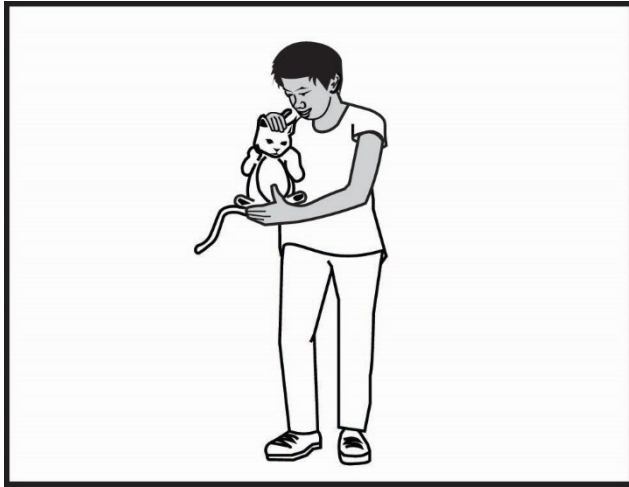

A. Noah wants to learn about animals.

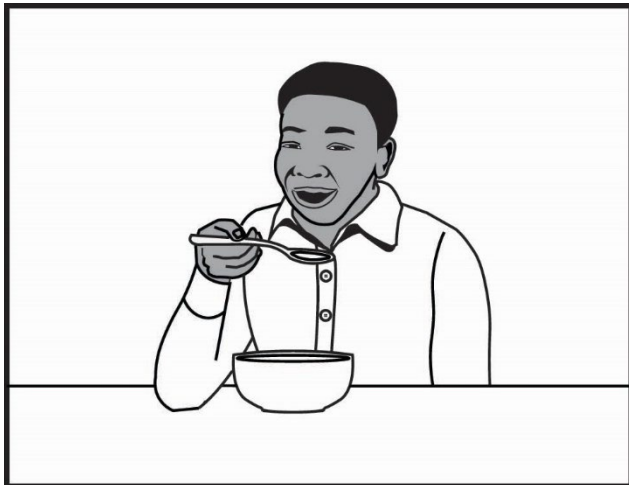

B. Josh eats breakfast at the kitchen table.



Session 3 – Item 28 Answer Options

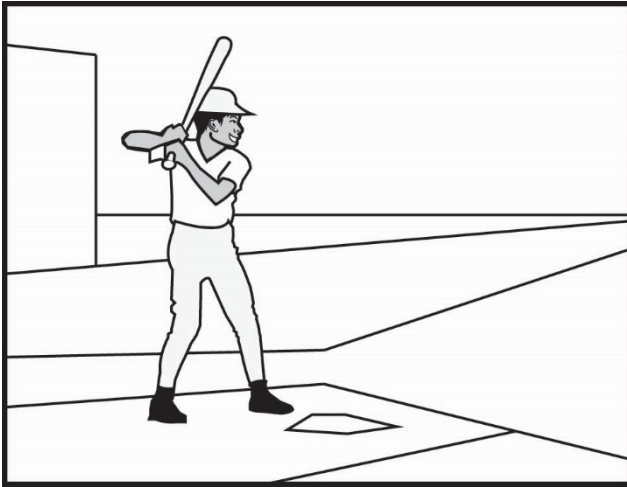

A. Noah is playing baseball outside.

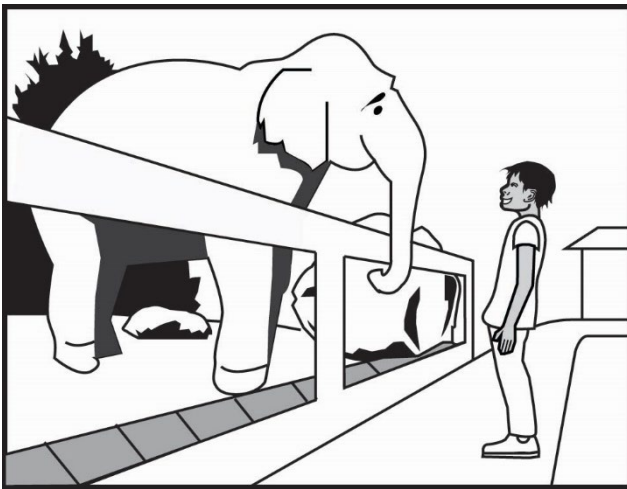

B. Noah is going to the zoo today.

Session 3 – Item 29 Answer Options

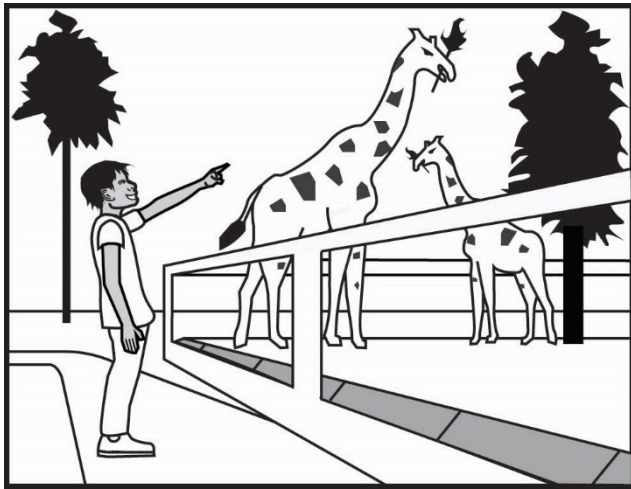

A. First, Noah visits the giraffes.

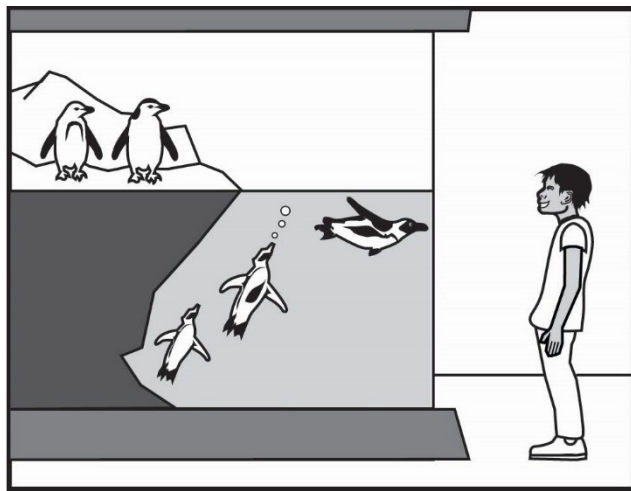

B. Next, Noah watches the penguins.

Session 3 – Item 30 Answer Options



A. The sun is shining.

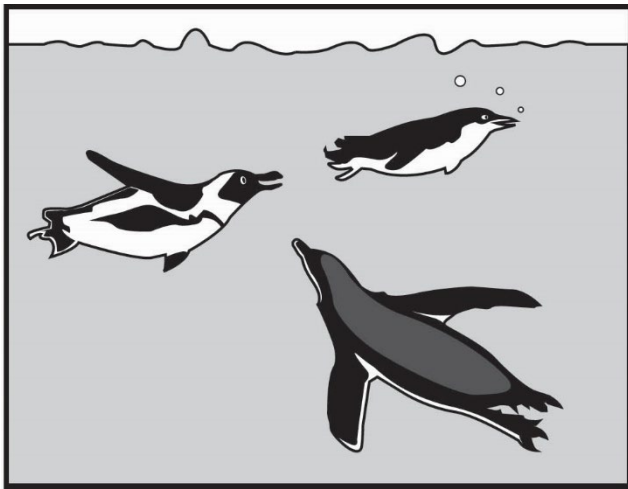

B. The penguins are playing.

Session 3 – Item 31 Answer Options



A. Noah likes to ride his bike to school.



B. Noah has seen lots of animals at the zoo.

**Session 3 – Item 32 Answer Options**

A. By the end

B. In the beginning

# Session 4

## **Grade 3 Stimulus Materials List for Writing Stimulus 2: “Preparing for Something”**

**Card 1a:** For Great Grandma

**Card 2a:** Illustrations of “For Great Grandma”

**Card 3a:** Me

**Card 4a:** Blank character card

**Card 5a:** Blank activity card

**Card 6a:** Capital letters, end punctuation, and complete sentences

**Card 7a-8a:** Response Template

## **For Great Grandma**

One day, Siu's family prepares a party at the clubhouse. It is her great grandma's birthday. She is 100. Siu is very excited. Her whole family is coming to the party.

First, her family makes her great-grandma's favorite foods. The noodles are fun to make. Then Siu helps make dumplings.

Siu feels happy because she loves her great grandma. Siu wants to give her a nice gift. But there is no time to shop.

In the end, Siu uses her pens and paper to write great grandma in Chinese. Siu's great grandma is very happy with her gift.

For Great Grandma Card 1a - **Must be securely destroyed after testing.**





For Great Grandma Card 2a - **Must be securely destroyed after testing.**

# Me

For Great Grandma Card 3a - **Must be securely destroyed after testing**

---

For Great Grandma Card 4a - **Must be securely destroyed after testing.**

For Great Grandma Card 5a - **Must be securely destroyed after testing**

---

Card intentionally left blank

**B b E e**

**. ! ?**

**Good writers use complete sentences.**

For Great Grandma Card 6a - **Must be securely destroyed after testing**

# Topic: Preparing for Something

One day, \_\_\_\_\_

prepares for \_\_\_\_\_

prepares for \_\_\_\_\_ at

First, \_\_\_\_\_

Then, \_\_\_\_\_

\_\_\_\_\_

\_\_\_\_\_

\_\_\_\_\_

\_\_\_\_\_

\_\_\_\_\_

\_\_\_\_\_

In the end, \_\_\_\_\_

\_\_\_\_\_

\_\_\_\_\_

\_\_\_\_\_

For Great Grandma Card 7a-8a - **Must be securely destroyed after testing**

# **LEAP CONNECT**

**Practice Test**