

LEAP CONNECT

Directions for Practice Test Administration

English Language Arts
Grade 6

(page is intentionally blank)

Table of Contents

Table of Contents	3
Purpose.....	4
Materials.....	4
Directions	4
Guidelines	5
Guidance on Printed Materials	5
Selected-Response Items	5
Reading Selected-Response Item Example	6
Constructed-Response Item.....	10
Procedures for Annotation of Writing CR Item.....	11
Procedures for Transcription of Writing CR Item	12
Use of a Scribe for Writing CR Item.....	13
Augmentative and Alternative Communication Guidelines for Writing	13
Session 1.....	14
Session 2.....	64
Session 3.....	78
Session 4.....	93

Purpose

The *Directions for Practice Test Administration* (DPTA) provides the Test Administrator (TA) of the LEAP Connect assessments with specific instructions for the administration of this particular test. Each DPTA provides the exact wording of the items to be used by the TA, the materials needed in the preparation of the test, and guidelines for how to present the items to the student.

Materials

Materials needed for the LEAP Connect Test Administration:

1. *Test Administration Manual* (TAM)
2. *Directions for Practice Test Administration* (DPTA)
3. *Procedures for Assessing Students Who Are Visually Impaired, Deaf, or Deaf-Blind*
4. *Grade 6 ELA Practice Test Reference Materials and Writing Stimuli*

Directions

1. **Know and follow all directions for test administration** provided in the TAM, DPTA, and *Procedures for Assessing Students Who Are Visually Impaired, Deaf, or Deaf-Blind*.
2. Be familiar with and utilize the Text to Speech (TTS) as appropriate. The DRC INSIGHT Assessment System includes TTS that will read aloud the text of directions, items, and answer options and will also read aloud standardized descriptive statements for tables, charts, graphs, and timelines.
 - a. This text is read to all students using a consistent rate of reading and tone of voice. If a student wishes to have any or all of the text repeated, click on the Starting Points button (between the Stop and Play/Pause buttons). Then use the mouse to select the starting point (blue circle) just before the text that needs to be repeated.
 - b. To change the volume or speed of the TTS or turn off the follow-along, select the Options button at the top of the screen, then select Audio Settings and adjust as desired.
 - c. If the TTS will not be used, the TA can turn off the volume and the follow-along using the Audio Settings. The TA must read the directions, items, answer option text, and graphic descriptions **exactly as written** using a consistent rate of reading and tone of voice.
3. Be familiar with and utilize the Alternative Text as appropriate. Alternative Text is bracketed and written in italics. Alternative Text is included for students who are blind or have a visual impairment and require graphics to be described. This Alternative Text includes descriptive statements for tables, charts, graphs, and any graphics necessary for appropriate interaction with the items to be described.

Guidelines

1. **Guiding a student response must be deliberately avoided.** Such cueing might include voice, rate of reading, positioning of correct response option, or body language that would suggest a preference or indicate a correct response. To ensure fidelity of test administration, the TA must use a consistent voice, rate of reading, positioning of response options, and body language during oral presentation.
2. If the TTS is not used, the TA may read the directions, item, response options, and graphic descriptions. All text must be read to the students **exactly as written**, (i.e., no paraphrasing or variation of speed to emphasize words in ways that provide hints as to correct or incorrect responses).
3. The Test Administrator (TA) may use statements to **encourage** the student to respond (e.g., “only one more to go,” “just five minutes until a break,” “keep working,” “I like the way you are listening and following directions”), but **does not** indicate either the correct or incorrect response.

Guidance on Printed Materials

ELA Practice Test Reference Materials and Writing Stimuli include required graphics and the answer options for each test item. The DPTA will prompt the TA when the required graphics are to be presented to the student. The answer options are included so they can be copied and used as needed (e.g., eye-gaze boards). *ELA Practice Test Reference Materials and Writing Stimuli* are distributed by the School Test Coordinator (STC).

The LEAP Connect ELA Practice Assessment includes one constructed-response writing item at each grade level. Writing Stimuli are provided for the constructed-response item. Writing Stimuli are distributed by the STC. Review the item and prepare materials as needed **prior to the administration** of the constructed-response writing item.

Selected-Response Items

Selected-response items are presented in the following order:

- Item stimulus (which may include a passage, passage part, picture, graphic, or other illustration)
- Item question
- Answer options (which are indicated by radio buttons and presented vertically)

Students independently select a response from the options. Being mindful that students will respond in a variety of ways (e.g., with words, gestures, eye gaze, communication devices, assistive technology, etc.), TAs can enter responses on behalf of the student.

Ensure that Augmentative and Alternative Communication (AAC) and Assistive Technology (AT) used routinely for instruction are available to support the student in communicating responses.

Reading Selected-Response Item Example

The LEAP Connect assessment items reflect grade-level content presented at varying degrees of complexity. The following item example illustrates a selected-response item and components which support the ways that students with a wide range of learner characteristics are presented with test items. The following item example does not reflect ALL content that is assessed in each grade-level content area and does not represent every degree of complexity.

Reading Item Example

Directions

We are going to read informational text about a writer named Mark Twain. He lived a long time ago and wrote books. After we read, you will be asked a question about this writer. Listen for what the author believes about Mark Twain.

The Life and Works of Mark Twain

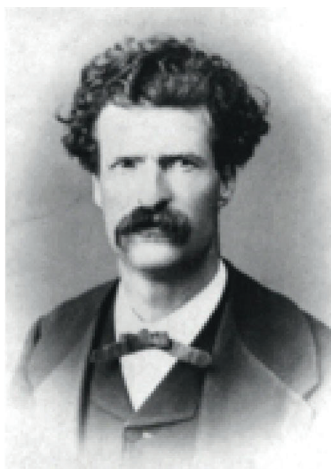

Mark Twain was an American writer.



Twain wrote many books. One of his best known books is The Adventures of Tom Sawyer. The books were set in Missouri. This is where Twain lived.



Twain first began by writing articles for his brother's newspaper. He became well-known after he wrote a funny short story.

[For students with visual impairment, read “This is a picture of a sailboat.”]

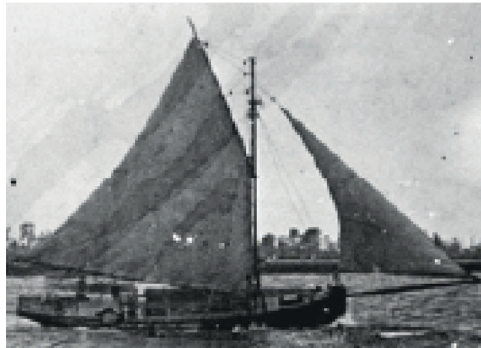

Twain traveled to many places. He visited libraries around the world. Twain became famous.

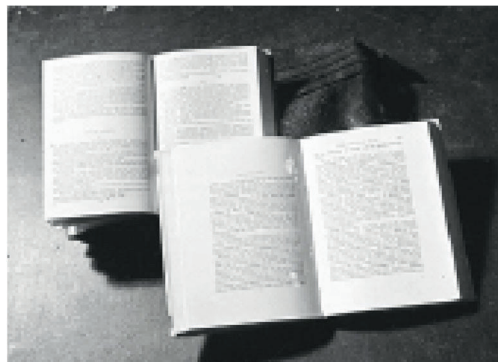

Mark Twain has inspired many people. He is seen as a great American author.

Item 1

Directions for TA that this is a two-part item.

TTS or TA reads item directions.

This is the first item of a two-part item.

We read about a writer named Mark Twain. We are going to read part of the text again. Then you will be asked a question. Listen for details that tell you that Mark Twain liked to travel.

[For students with visual impairment, read "This is a picture of a sailboat."]

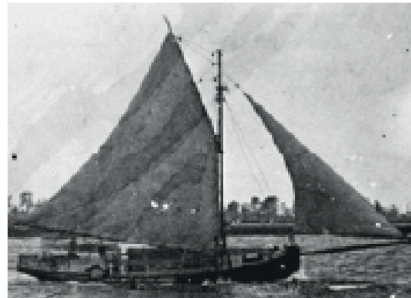

TTS or TA reads item text.

TA reads the alternative text for students with visual impairment to describe the picture.

Twain traveled to many places. He visited libraries around the world. Twain became famous.

TTS or TA reads question text.

Which sentence tells that Mark Twain liked to travel?

Point to each answer option as the Text to Speech (TTS) or Test Administrator (TA) reads each option.

[For students with visual impairment, read "A. This is a picture of a pad of paper with a drawing on it."]

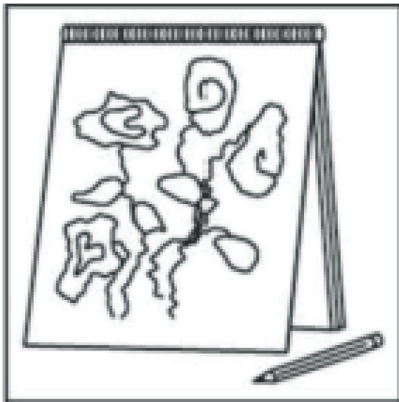

Directions for TA to point to each answer option as the TTS or TA reads each option.

TTS or TA reads answer options.

A. He drew pictures.

[For students with visual impairment, read “B. This is a picture of famous people at a dinner party.”]



B. He became famous.

[For students with visual impairment, read “C. This is a picture of men riding on top of and in a covered wagon pulled by horses.”]



TA asks student if they would like to read this part again. If the student says yes, the TA either activates the starting point for the TTS to read the passage part or reads the passage part again.

C. He traveled to many places.

Would you like to read this part again before you answer the question?

Constructed-Response Item

The constructed-response (CR) item requires the student to produce a response to a writing prompt (i.e., expressive language). The item is presented to the student in a standardized, scripted sequence of steps that include statements read by the TTS and TA and directions for the presentation of grade- and prompt-specific materials that need to be prepared as appropriate for each student. The Student Response Template is identified by a card number for each CR item in the Writing Stimuli. The student may use the Student Response Template located in the *ELA Reference Materials and Writing Stimuli* to write a response to the CR item, but **the final product is entered into the DRC INSIGHT Assessment System**. Please note that if the TA makes the determination that a student is capable of entering an online response utilizing a keyboard, the student is not required to use the Student Response Template and may type and edit the response in the response spaces in the DRC INSIGHT Assessment System.

A TA needs to determine the way in which a student will create a constructed response in writing. The student can use the Student Response Template to write a response or

can enter an online response utilizing a keyboard. The following statements are provided to assist TAs in determining whether to allow the student to enter an online response into the DRC INSIGHT Assessment System.

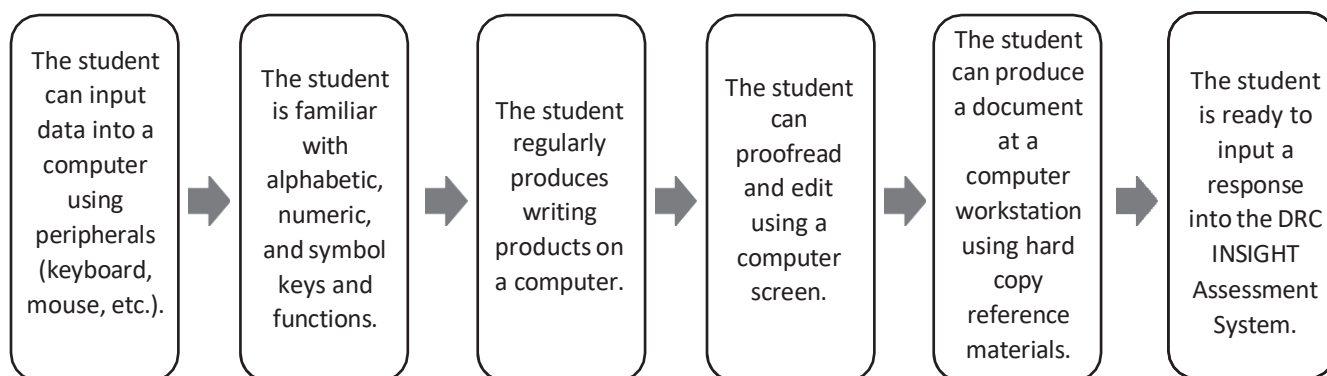

The CR writing prompt is administered in the following manner:

1. The student is presented with the writing task and the text type (e.g., story or essay) to be produced.
2. The student is then presented with a model of the text type.
3. The TA presents the steps of the writing task as planning, writing, revising, and editing a response, using a script that includes references to materials to present to the student to support the construction of a response.
4. First, the student organizes ideas related to the topic. Next, the student writes a response using the provided Student Response Template or types into the DRC INSIGHT Assessment System. Then the student is allowed to revise and edit the response. Last, the TA reads aloud the finished product to the student.
5. If the student types the response into the DRC INSIGHT Assessment System, the student may not utilize the computer's browser functions during CR item administration.
6. If the student did not type the response into the DRC INSIGHT Assessment System, the TA must transcribe the student response into the DRC INSIGHT Assessment System in the appropriate boxes. **The TA must also type any necessary annotations in the text box beneath the item. (See *Procedures for Annotation* and *Procedures for Transcription* below.)**

Procedures for Annotation of Writing CR Item

To ensure student's written product is easily interpreted during scoring (e.g., use of inventive spelling or symbolic expressions), the TA **must** provide annotations in the DRC INSIGHT Assessment System in the text box beneath the item labeled "*For Test Administrator use if annotations are necessary.*" The annotation is to be written by the TA and must not alter the intent of the student's original response; rather annotation ensures that the response is interpretable and meaningful to a scorer.

After the student has finished composing their written responses, the TA will read the student's response and do the following:

- Add annotation to describe or clarify the intended meaning of pictures, symbols, or objects included in the student's original response.
- Add annotation to clarify incorrect spelling as needed to ensure correct interpretation.
- Make annotations in the proper location (the text box beneath the item) to distinguish from the student's original response.
- If a student types an uninterpretable word (e.g., inventive spelling), type the intended word in parentheses directly following the uninterpretable word in the DRC INSIGHT Assessment System to clarify the student wording. DO NOT remove student wording or phrasing.
- Not include comments or explanations of the student's response except if needed for clarification.
- Provide an opportunity for the student to review and modify what has been annotated.
- The annotation box is **not** intended for TA feedback about the CR item or the LEAP Connect assessments. TAs may send any feedback or questions to assessment@la.gov.

Procedures for Transcription of Writing CR Item

If a student did not type the response into the DRC INSIGHT Assessment System, the TA must transcribe the student's response including any annotations into the response area(s) for that item.

The TA will:

- Enter the response after completing the administration of the CR item.
- Enter the entire response exactly as the student has written it and annotate as appropriate (see *Procedures for Annotation of Writing CR Item*).
- Not revise, edit, or alter the student's response in any way, unless directed to do so by the student.
- Not provide feedback regarding any aspect of the student's response unless directed to do so by the student.

If the student is able to provide a response to the system independently, the TA is encouraged to allow the student to do so. In this case, the TA is not required to complete the task of transcription.

After the TA has transcribed and provided annotations for a constructed-response item, the item is considered completed. When all transcriptions and annotations are completed for the CR item, the session is completed and the test must be submitted.

Use of a Scribe for Writing CR Item

The TA may decide before testing begins, based on student need, that the use of a scribe is the best way to capture the student's response for the writing CR item. This process should be practiced with the student prior to testing during regular classroom instruction in order to ensure that the student and the TA understand the process. The process of scribing should not be a barrier for the student. If a scribe is utilized, the scribe must: 1) transcribe the work into the online system and 2) annotate. The role of scribe can be completed by either a TA or a district employee under the direction of a qualified, trained TA. For the ELA test only, **an accommodation for scribe or transcription is not required to be included in the student's IEP.**

The scribe will:

- Begin the session with an introduction, explain the process and direct the student to indicate when to use capitalization and punctuation when needed, and must allow the student to revise and edit what the scribe has written.
- Write exactly what the student communicated on paper or directly into the DRC INSIGHT Assessment System.
- Correctly spell all words.
- Capitalize words or punctuate text only when indicated by the student.
- Make student-requested changes, even if incorrect.
- Allow the student to edit for punctuation, capitalization, or other edits as described in the DPTA.
- Orally confirm meaning of homonyms and commonly used homophones (e.g., than and then; to, two, and too; there, their, and they're).

Augmentative and Alternative Communication Guidelines for Writing

Ensure that AAC and AT that are used routinely for instruction are available to support the student in communicating answer responses. Allow the student to complete the tasks using their preferred method of communication (e.g., pointing, eye gaze, assistive technology, oral response, sign language).

Please refer to the *LEAP Connect Test Administration Manual, Appendix B*, which provides detailed methods and protocols for using AAC systems and devices to respond to the writing CR items.

Session 1

Provide student with Timeline 1, “The History of Pralines,” from the Grade 6 ELA Practice Test Reference Materials.

Directions

We are going to look at and read a timeline about pralines. The timeline explains the history of pralines. After we read, you will be asked a question. Listen for what the text is about.

Point to the timeline as the TTS or TA reads the graphic description.

[Graphic description: “This is a timeline about pralines throughout history. First, in the sixteen hundreds, a French cook brings the recipe to the United States. Then, in the seventeen hundreds, the recipe changes and uses pecans instead of almonds. Finally, in the two-thousands, pralines are still a popular treat today. Lots of people eat them.”]

The History of Pralines

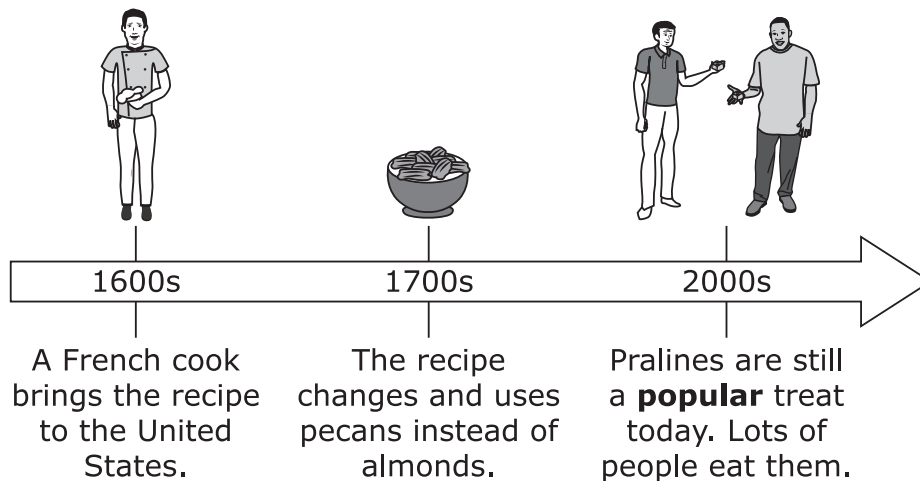

Item 1

What is this timeline about?

Point to each option as the TTS or TA reads each option.

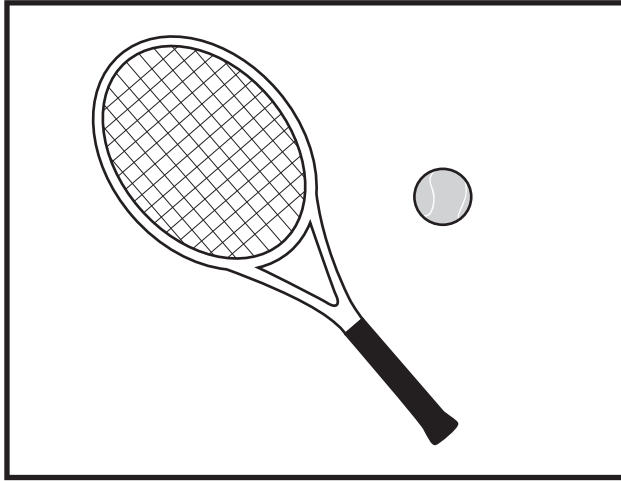

A. tennis

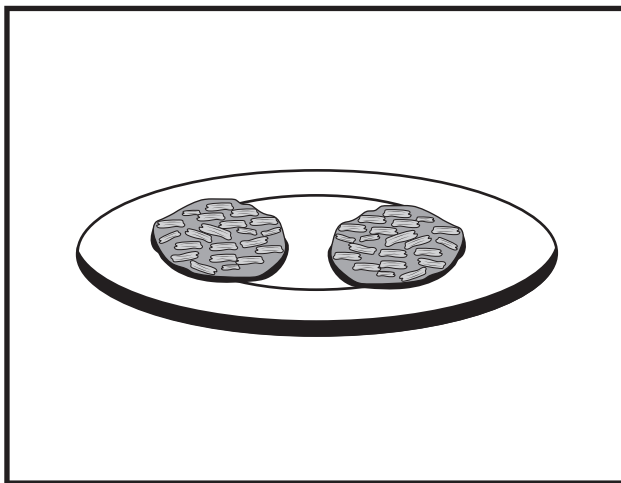

B. pralines

Would you like to read the timeline again before you answer the question?

Provide student with Timeline X, "The History of Pralines," from the Grade 6 ELA Reference Materials.

Item 2

We read about pralines. We are going to read the timeline again. Then you will be asked a question. Listen for how the recipe for pralines came to the United States.

Point to the timeline as the TTS or TA reads the graphic description.

[Graphic description: "This is a timeline about pralines throughout history. First, in the sixteen hundreds, a French cook brings the recipe to the United States. Then, in the seventeen hundreds, the recipe changes and uses pecans instead of almonds. Finally, in the two-thousands, pralines are still a popular treat today. Lots of people eat them."]

The History of Pralines

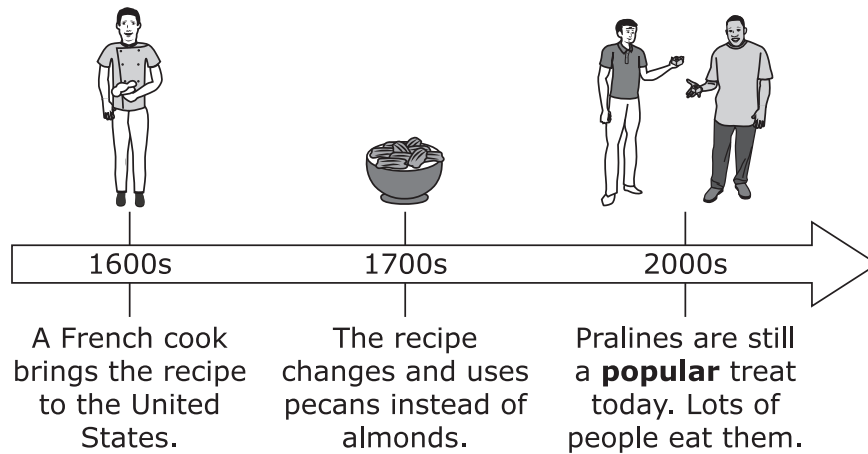

How did the recipe for pralines come to the United States?

Point to each option as the TTS or TA reads each option.



A. from a cook in France



B. from a teacher in Canada

Would you like to read the timeline again before you answer the question?

Provide student with Timeline 1, "The History of Pralines," from the Grade 6 ELA Reference Materials.

Item 3

We read about pralines. We are going to read the timeline again. Listen for a fact about pralines.

Point to the timeline as the TTS or TA reads the graphic description.

[Graphic description: "This is a timeline about pralines throughout history. First, in the sixteen hundreds, a French cook brings the recipe to the United States. Then, in the seventeen hundreds, the recipe changes and uses pecans instead of almonds. Finally, in the two-thousands, pralines are still a popular treat today. Lots of people eat them."]

The History of Pralines

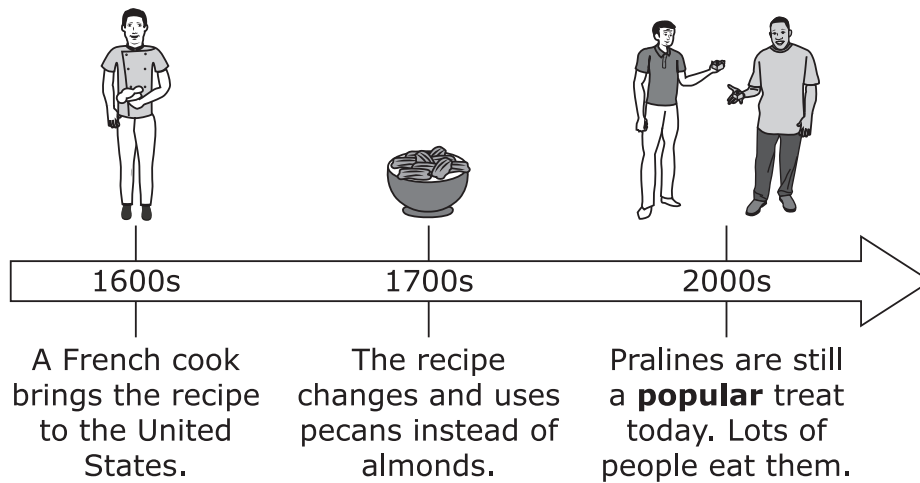

What are pralines made with?

Point to each option as the TTS or TA reads each option.

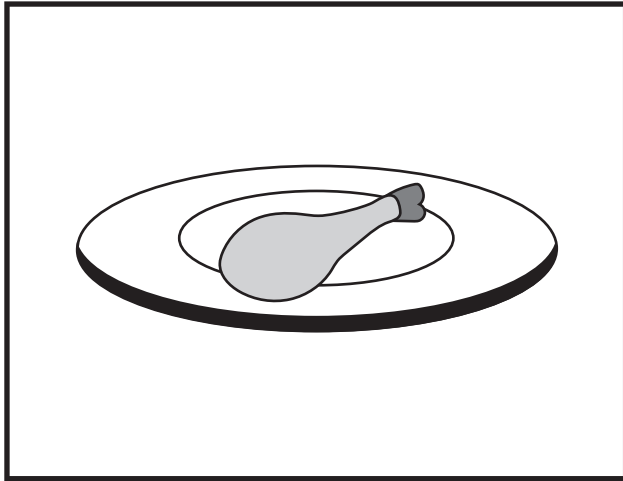

A. chicken

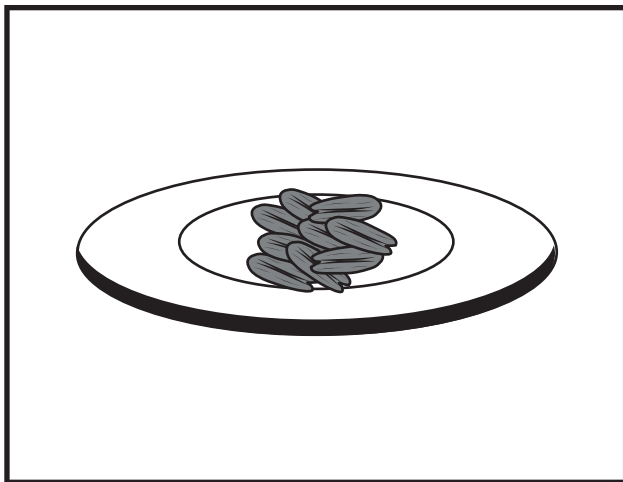

B. pecans

Would you like to read the timeline again before you answer the question?

Item 4

Now, we are going to read and look at a recipe for pralines. After we read, you will be asked a question. Listen for what happens to the butter, sugar, and cream.

Pralines

Point to each item as the TTS or TA reads the graphic description.

Items:

[Graphic description: "The items you will need to make pralines are butter, sugar, cream, vanilla, and pecans."]



Steps:



1. Add butter, sugar, and cream to a pan.

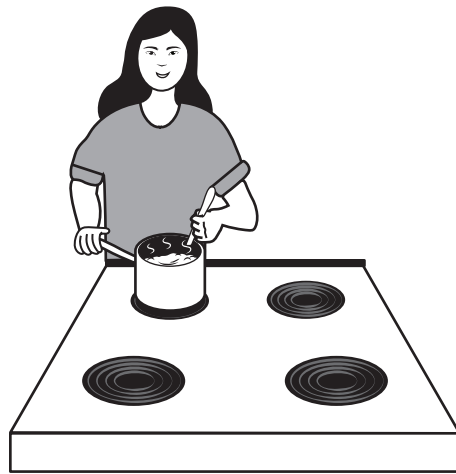

2. Turn on the stove. Cook and stir for five minutes.



3. Take the pan off the heat. Add pecans and vanilla. Stir the mixture.



4. Pour it onto wax paper. Let it cool and enjoy!

What is the butter, sugar, and cream put into?

Point to each option as the TTS or TA reads each option.

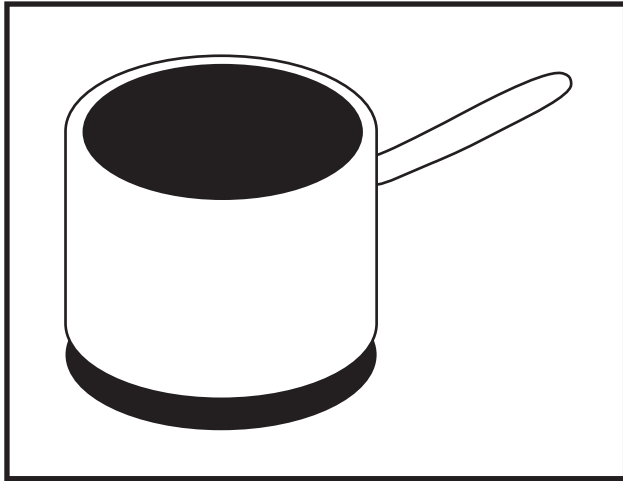

A. a pan

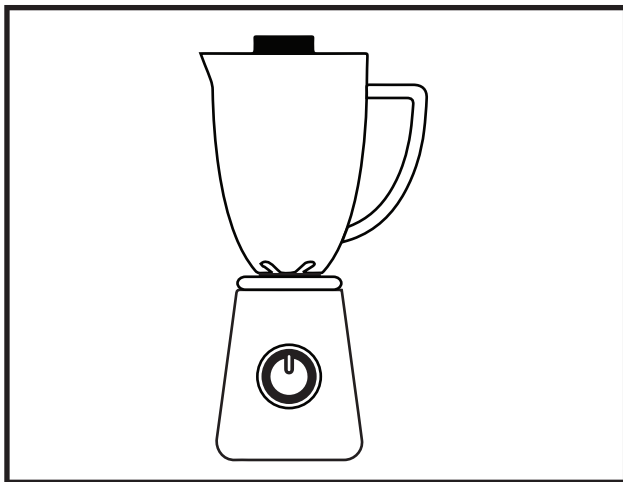

B. a blender

Would you like to read the text again before you answer the question?

Item 5

We read about pralines. We are going to read and look at the recipe again. Listen for the steps in making pralines.

Pralines

Point to each item as the TTS or TA reads the graphic description.

[Graphic description: "The items you will need to make pralines are butter, sugar, cream, vanilla, and pecans."]

Items:

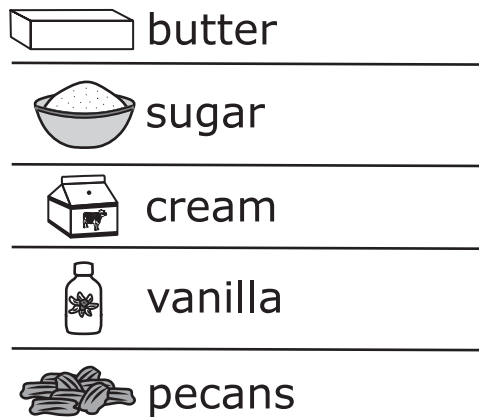

Steps:



1. Add butter, sugar, and cream to a pan.

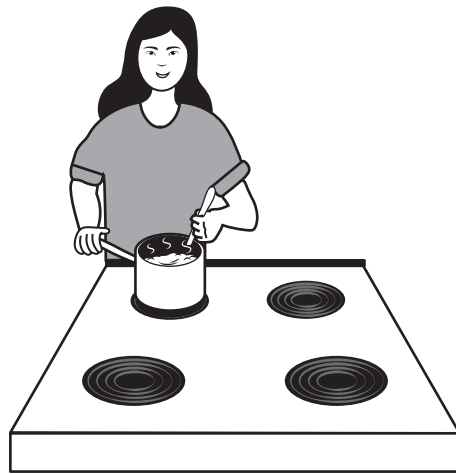

2. Turn on the stove. Cook and stir for five minutes.



3. Take the pan off the heat. Add pecans and vanilla. Stir the mixture.



4. Pour it onto wax paper. Let it cool and enjoy!

Which is a step in making pralines?

Point to each option as the TTS or TA reads each option.

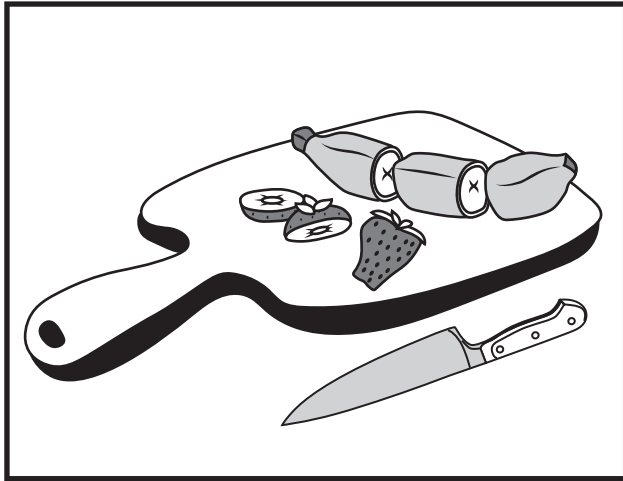

A. Cut up the fruit.

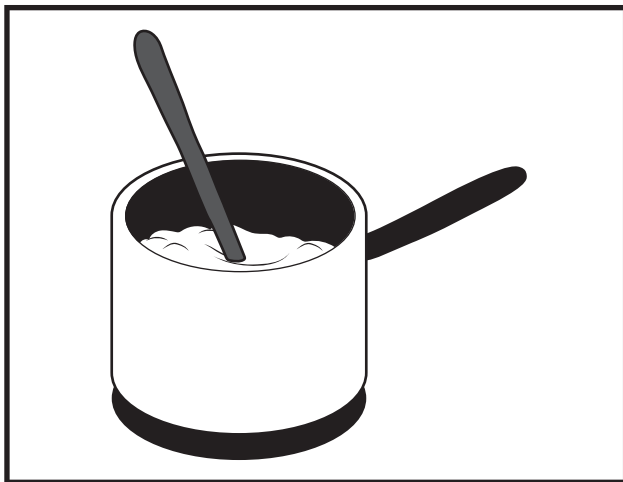

B. Stir the mixture.

Would you like to read the text again before you answer the question?

Provide student with Timeline 1, "The History of Pralines," from the Grade 6 ELA Reference Materials.

Item 6

We read about pralines. We are going to read part of the timeline again. Listen for clues that tell you what the word **popular** means.

Point to the timeline event as the TTS or TA reads the graphic description.

[Graphic description: "This is part of the timeline about pralines throughout history. In the two-thousands, pralines are still a popular treat today. Lots of people eat them."]

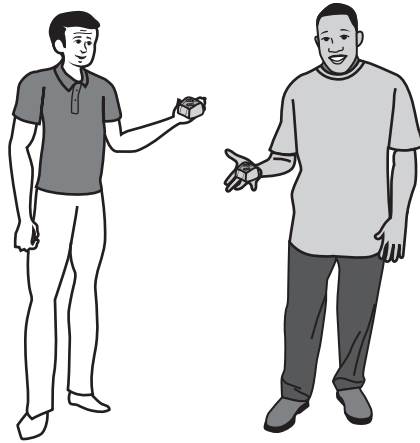

2000s:

Pralines are still a
popular treat today.
Lots of people eat
them.

Point to the bolded word.

What does **popular** mean in this sentence?

Point to each option as the TTS or TA reads each option.

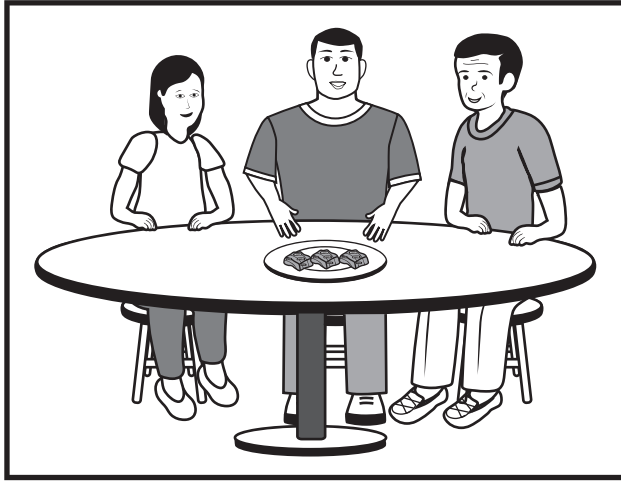

A. liked by many people

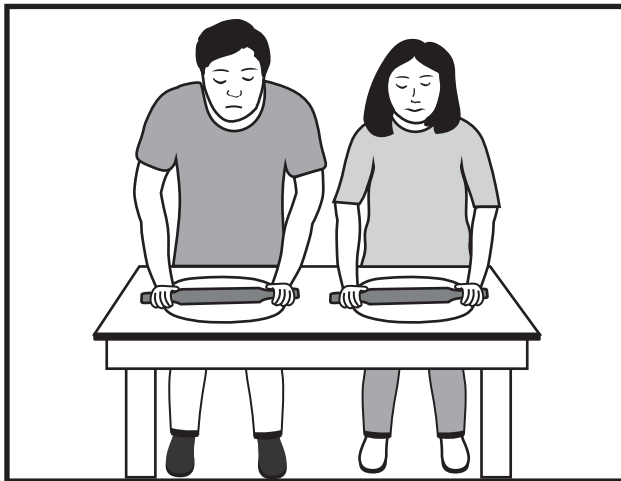

B. hard for people to make

Would you like to read this part again before you answer the question?

Directions

We are going to read a story about a girl who wants to play for the Saints football team. After we read, you will be asked questions about the summary. Listen for what happens at the beginning, middle, and end of the story.

Graciela's Football Dream



Graciela loves football. She plays often with her brothers. The New Orleans Saints are Graciela's favorite football team. She watches every game on television. She hopes to play for the Saints. Graciela tells her brothers she wants to be the Saints' quarterback.

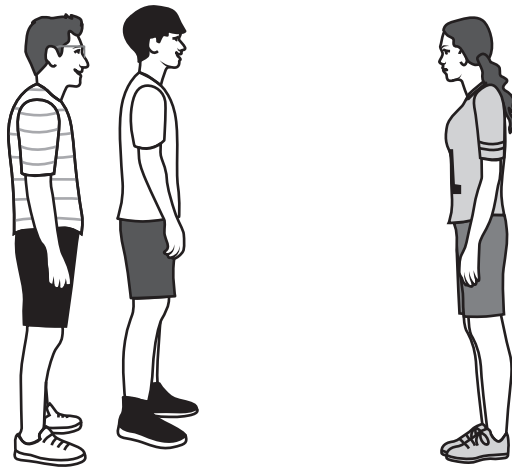

Graciela's brothers tell her she cannot play for the Saints. They say that girls do not play professional football. This hurts Graciela's feelings. Her father tells her to not give up. He says she could be the first girl player on the team.

Graciela decides to practice football every day. At first, she and her brothers throw the football in their backyard. Then, Graciela starts throwing the ball far. The backyard is too small. They go to the park. Now she can throw farther. Graciela sees Drew Brees at the park. He is a famous quarterback who played for the Saints.

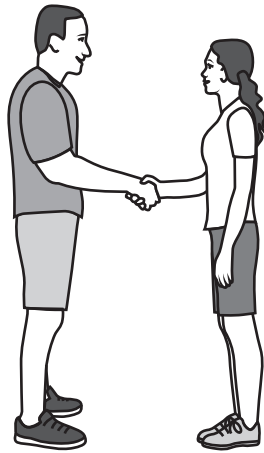

Graciela wants to talk to Brees. She says, “Hi, you are my favorite quarterback!” He says, “Thank you.” Graciela shares her dream of becoming a quarterback for the Saints. She tells him that she hopes to be the first girl to play on the team.

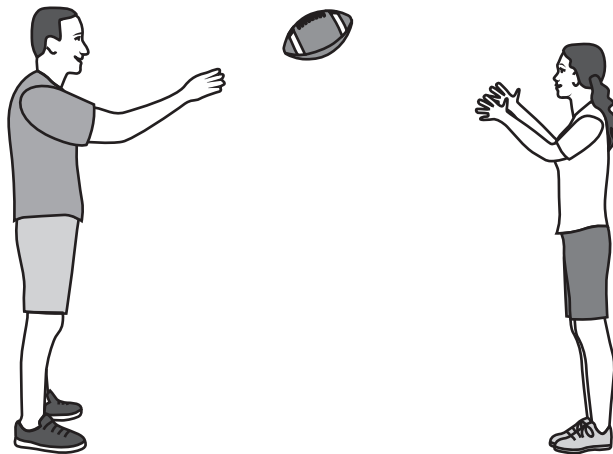

Brees asks Graciela to show him how well she throws. She excitedly agrees. Graciela and Brees throw the football to each other. He is **impressed** with her throwing skills. Brees tells Graciela that she is good at throwing the football. He believes she could be a winning quarterback of any team. Graciela jumps for joy! She continues to dream of playing for the Saints.

Item 7

Remember, a summary tells what happens in the story and does not include the reader's opinion.

What happens at the beginning of the story?

Point to each option as the TTS or TA reads each option.

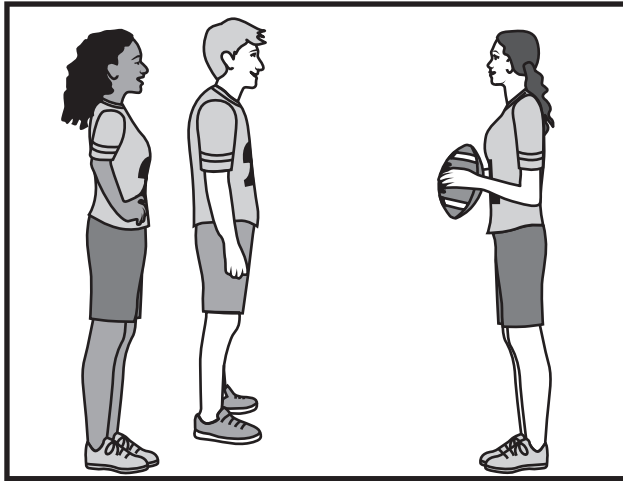

A. Graciela plays on a girls and boys football team called the Saints.

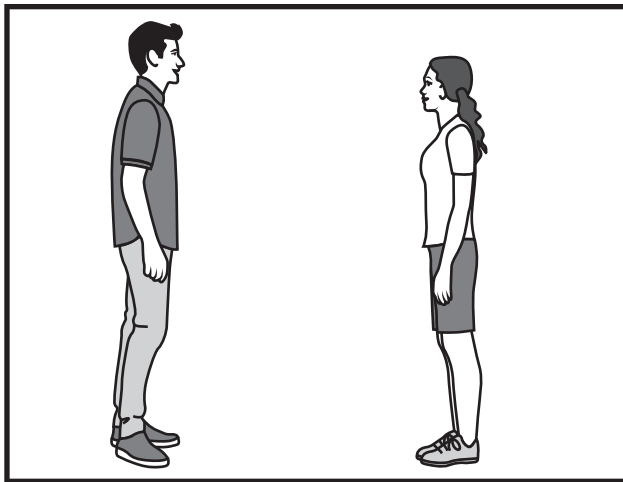

B. Graciela's father is a good father for encouraging her to play for the Saints.

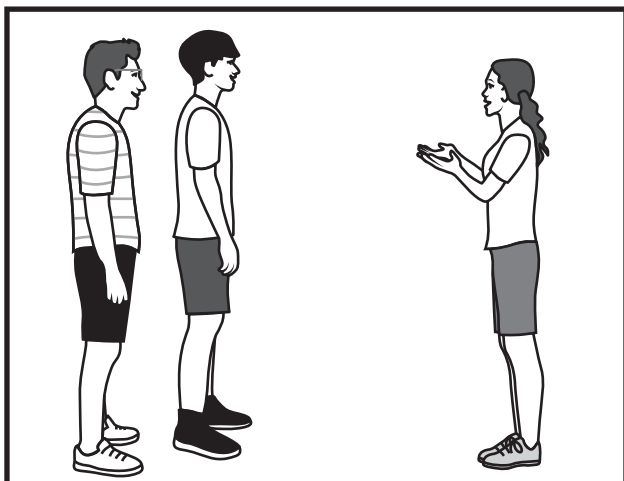

C. Graciela tells her brothers that she wants to play quarterback for the Saints.

Would you like to read the story again before you answer the question?

Item 8

What happens in the middle of the story?

Point to each option as the TTS or TA reads each option.

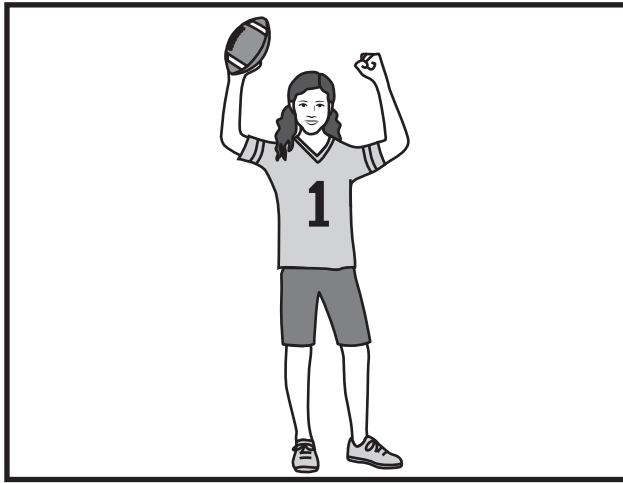

A. Graciela is better at football than her brothers and her dad.

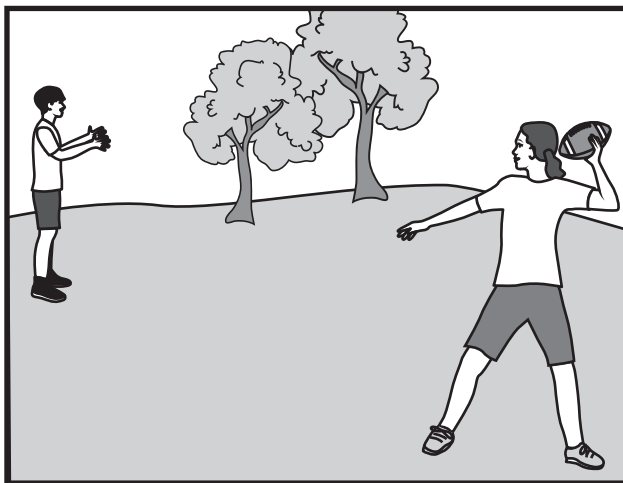

B. Graciela begins practicing at the park so she can throw farther.

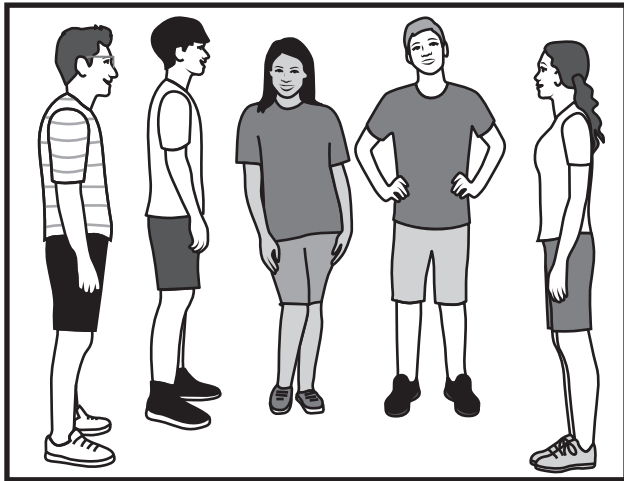

C. Graciela and her brothers meet friends at the park to play football.

Would you like to read the story again before you answer the question?

Item 9

What happens at the end of the story?

Point to each option as the TTS or TA reads each option.

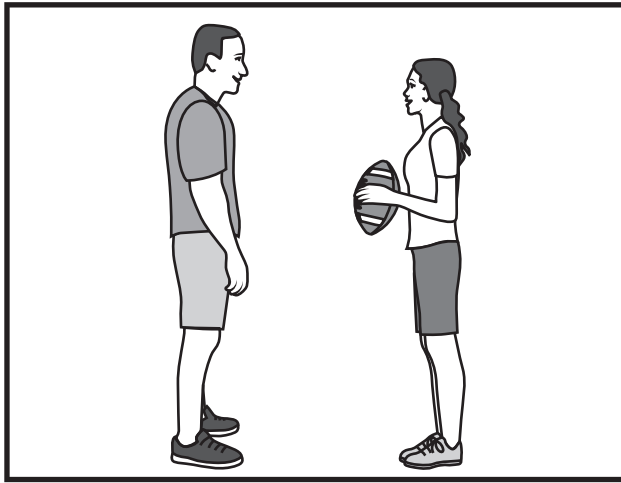

- A. Drew Brees tells Graciela that she could be a winning player for any football team.



- B. Drew Brees plays football with Graciela and all of her friends.



C. Drew Brees is the best professional football player ever.

Would you like to read the story again before you answer the question?

Item 10

We read a story about Graciela who wants to play for the Saints football team. We are going to read part of the story again. Then you will be asked a question. Listen for what hurts Graciela's feelings.

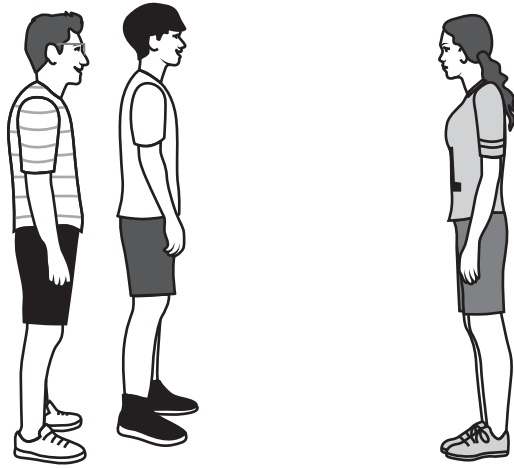

Graciela's brothers tell her she cannot play for the Saints. They say that girls do not play professional football. This hurts Graciela's feelings. Her father tells her to not give up. He says she could be the first girl player on the team.

Remember, details tell you more about the people and actions in the story.

What hurts Graciela's feelings?

Point to each option as the TTS or TA reads each option.

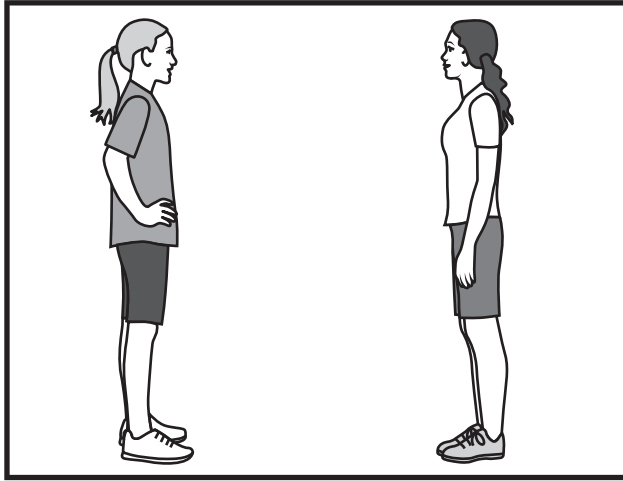

A. Her friend asks her to go to the park and play.

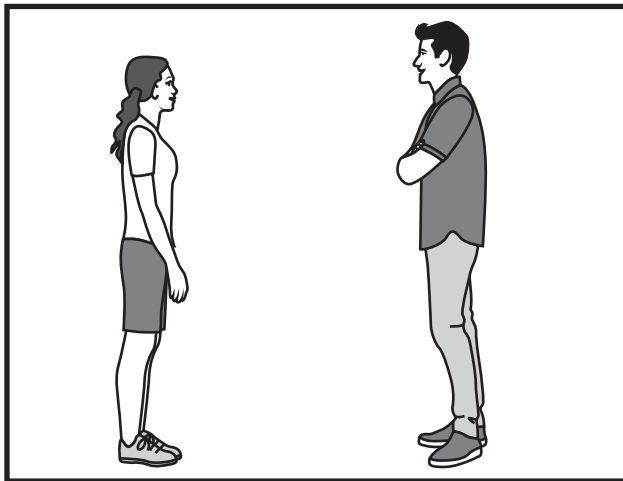

B. Her father tells her she could be the first girl on the team.

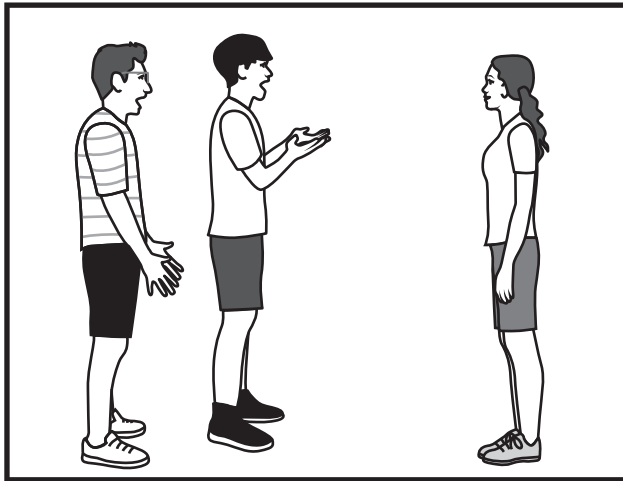

C. Her brothers tell her that girls do not play professional football.

Would you like to read this part again before you answer the question?

Item 11

We read a story about Graciela who wants to play for the Saints football team. We are going to read part of the story again. Then you will be asked a question. Listen for what Graciela does to get better at football.

Graciela decides to practice football every day. At first, she and her brothers throw the football in their backyard. Then, Graciela starts throwing the ball far. The backyard is too small. They go to the park. Now she can throw farther. Graciela sees Drew Brees at the park. He is a famous quarterback who played for the Saints.

Remember, details tell you more about the people and actions in the story.

Graciela wants to get better at football.

Which detail shows that Graciela wants to get better at football?

Point to each option as the TTS or TA reads each option.

- A. “Graciela sees Drew Brees at the park.”
- B. “Graciela decides to practice football every day.”
- C. “Graciela and Brees throw the football to each other.”

Would you like to read this part again before you answer the question?

Item 12

We read a story about Graciela who wants to play for the Saints football team. We are going to read part of the story again. Then you will be asked a question. Listen for clues that tell you what the word **impressed** means.

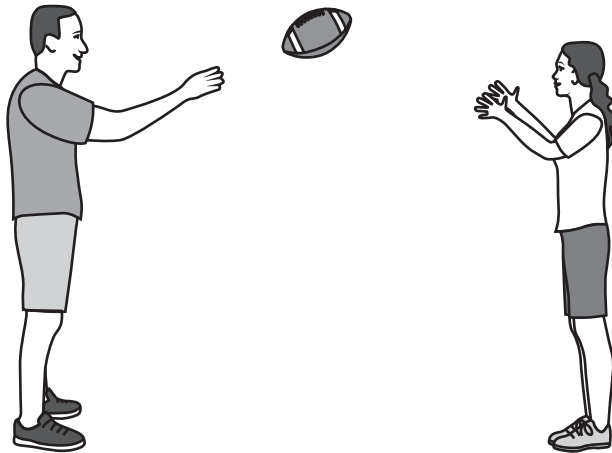

Brees asks Graciela to show him how well she throws. She excitedly agrees. Graciela and Brees throw the football to each other. He is **impressed** with her throwing skills. Brees tells Graciela that she is good at throwing the football. He believes she could be a winning quarterback of any team. Graciela jumps for joy! She continues to dream of playing for the Saints.

Point to the bolded word.

What does the word **impressed** mean in this sentence?

Point to each option as the TTS or TA reads each option.

- A. He is amazed with her throwing skills.
- B. He is bored with her throwing skills.
- C. He is concerned with her throwing skills.

Would you like to read this part again before you answer the question?

Directions

We are going to read an informational text about an American Indian event called the Tunica-Biloxi Pow Wow. After we read, you will be asked questions about a summary.

The Tunica-Biloxi Pow Wow: A Place for Learning



The Pow Wow

Every May, the people of the Tunica-Biloxi American Indian tribe hold a pow wow in Marksville, Louisiana. A pow wow is a celebration and a chance for all people to learn about American Indians. Other tribes come too. It is a chance for different tribes to come together.



People who are not American Indian can go to the pow wow too.

The pow wow is good because you can learn new things. You can learn about American Indian history. You can learn how American Indians live now and in the past. And you can learn about American Indian music and dance.



At the pow wow, there are dancers and singers. Some try to win prizes with their **performance**. They wear special costumes and dance to special music. The costumes have beads and feathers. Many are made with leather and are very colorful.

The Round Dance



At the pow wow, there is an event called the round dance. The round dance is for everyone. People make a circle and dance. It is a good way to make new friends and to celebrate. The round dance is an old custom that brings different people together.

Art

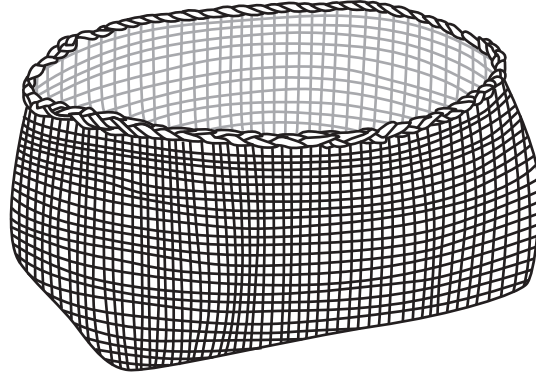

There are artists who sell crafts. They sell handmade baskets. The baskets are made from pine needles or river cane. The river cane is dyed red, yellow, or black. The baskets have designs that look like alligators, snakes, and birds. Each design represents common animals in Louisiana and Mississippi.

American Indian artists sell jewelry. Some sell pottery. The pottery has designs of flowers and animals. All of it is handmade. Each piece is different and special.

Item 13

This is the first item of a two-part item. Student may not return to this item after responding to this item.

Remember a summary should only include information from the text and does not include the reader's opinion.

Which sentence would be part of a summary of this text?

Point to each option as the TTS or TA reads each option.



A. River cane is dyed different colors.

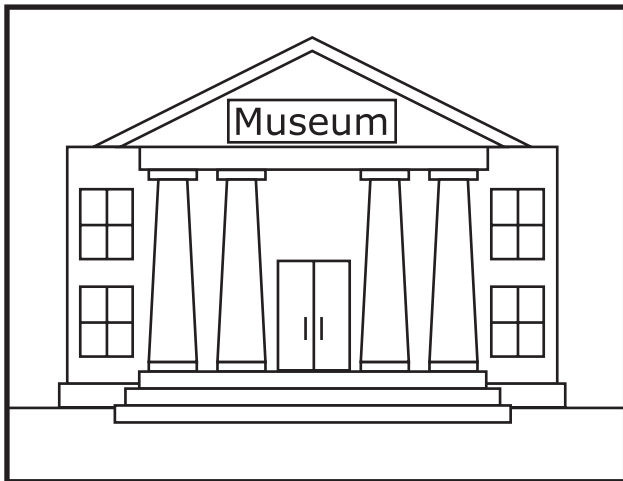

B. A pow wow is fun like going to a museum.

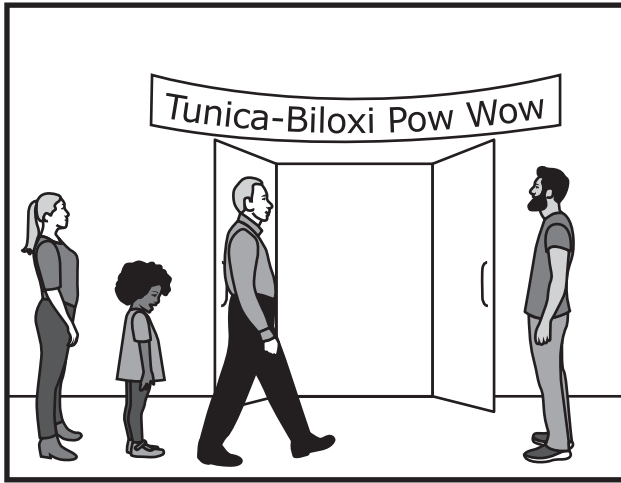

C. The Tunica-Biloxi Pow Wow is held every May in Marksville, Louisiana.

Would you like to read the text again before you answer the question?

This is the first item of a two-part item. Student may not return to this item after responding to this item

Item 14

This is the second item of a two-part item. Student may not return to the previous item.

This sentence is part of a summary of the text.

Point to the sentence as the TTS or TA reads the sentence.

The Tunica-Biloxi Pow Wow is held every May in Marksville, Louisiana.

What is another sentence that would be part of the summary?

Point to each option as the TTS or TA reads each option.

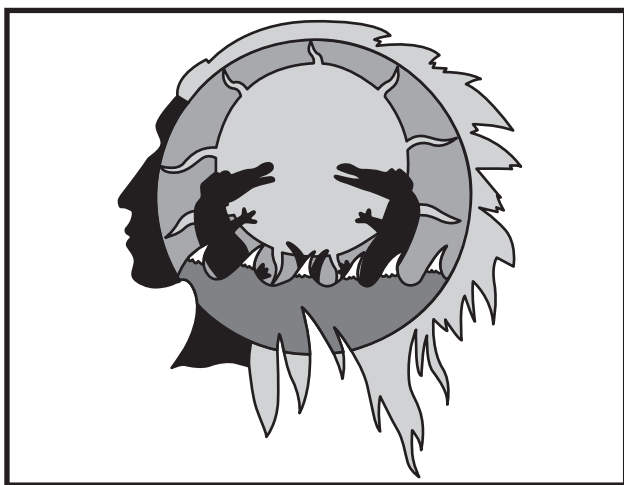

A. A pow wow is a good place to learn about American Indians.

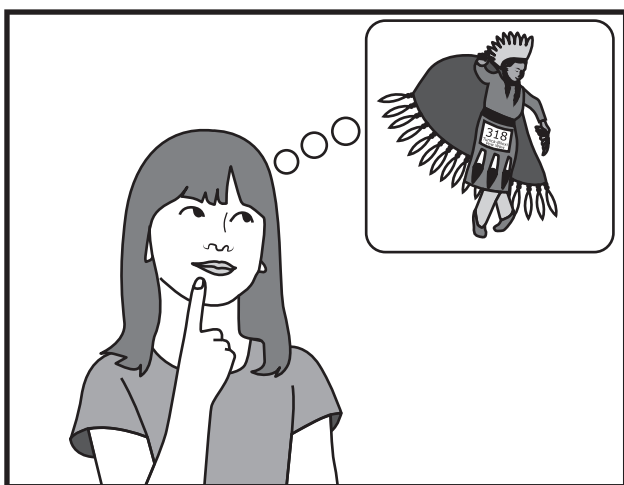

B. I want to go to a pow wow to learn American Indian dances.

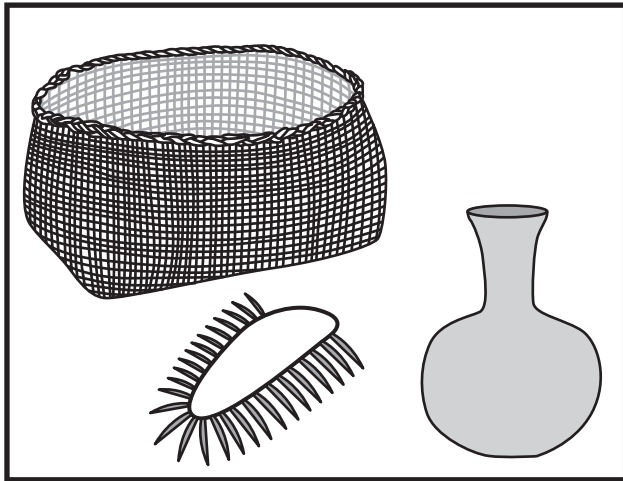

C. American Indian art is nice to collect.

Would you like to read this part again before you answer the question?

Item 15

We read about the Tunica-Biloxi Pow Wow. We are going to read part of the text again. Then you will be asked about the author’s claim that pow wows are a good way to learn new things.

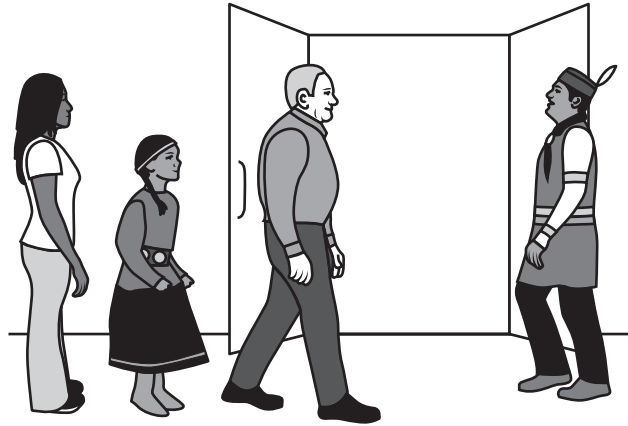

The pow wow is good because you can learn new things. You can learn about American Indian history. You can learn how American Indians live now and in the past. And you can learn about American Indian music and dance.

Remember, a claim is what the author thinks about a topic.

What fact does the author use to support the claim that the Tunica-Biloxi Pow Wow is good because you can learn new things?

Point to each option as the TTS or TA reads each option.

MAY						
						1
2	3	4	5	6	7	8
9	10	11	12	13	14	15
16	17	18	19	20	21 Tunica-Biloxi Pow Wow	22
23	24	25	26	27	28	29
30	31					

A. The Tunica-Biloxi Pow Wow is held every year in May.

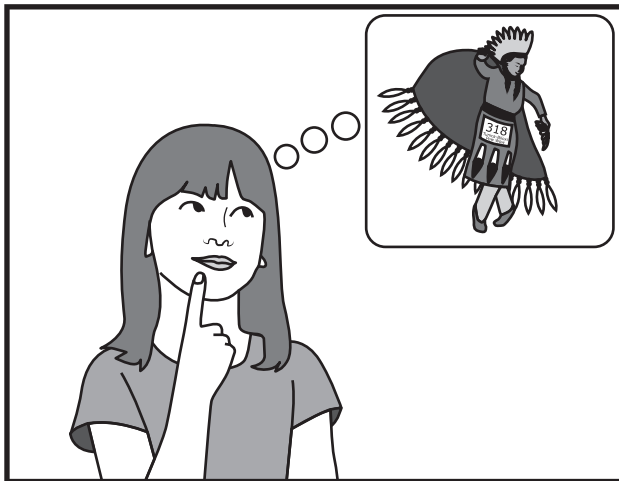

B. Pow wows teach people about American Indian history and life.



C. Marksville, Louisiana is home to the Tunica-Biloxi Pow Wow.

Would you like to read this part again before you answer the question?

Item 16

We read about the Tunica-Biloxi Pow Wow. We are going to read part of the text again. After we read, you will be asked a question about the round dance.

The Round Dance



At the pow wow, there is an event called the round dance. The round dance is for everyone. People make a circle and dance. It is a good way to make new friends and to celebrate. The round dance is an old custom that brings different people together.

Which detail supports that the round dance is a good place to make new friends?

Point to each option as the TTS or TA reads each option.



A. The round dance is easy to learn.



B. The round dance is a common event at a pow wow.



C. The round dance is an old custom that brings people together.

Would you like to read this part again before you answer the question?

Item 17

We read about the Tunica-Biloxi Pow Wow. We are going to read part of the text again. After we read, you will be asked a question about the art.

Art

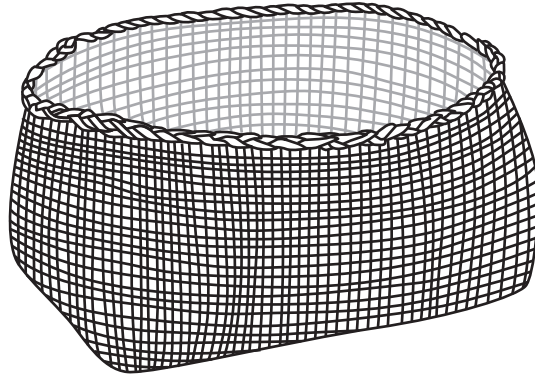

There are artists who sell crafts. They sell handmade baskets. The baskets are made from pine needles or river cane. The river cane is dyed red, yellow, or black. The baskets have designs that look like alligators, snakes, and birds. Each design represents common animals in Louisiana and Mississippi.

American Indian artists sell jewelry. Some sell pottery. The pottery has designs of flowers and animals. All of it is handmade. Each piece is different and special.

Which sentence supports that the art is handmade?

Point to each option as the TTS or TA reads each option.

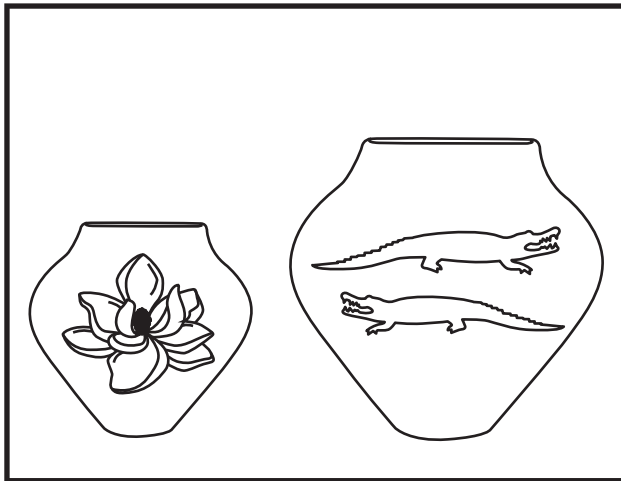

A. The pottery has designs of flowers and animals.

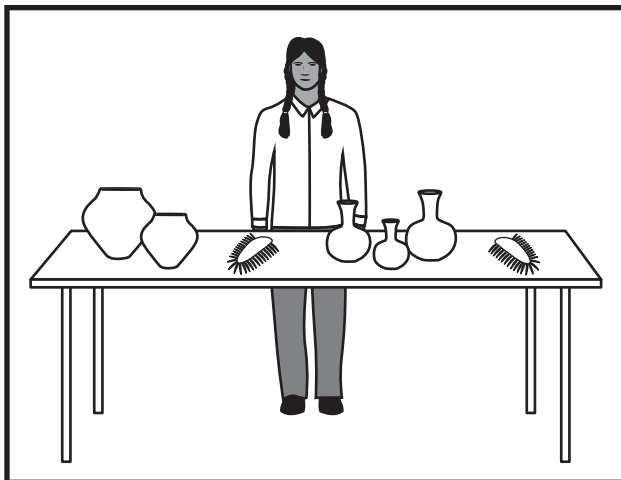

B. American Indian artists sell art and jewelry.

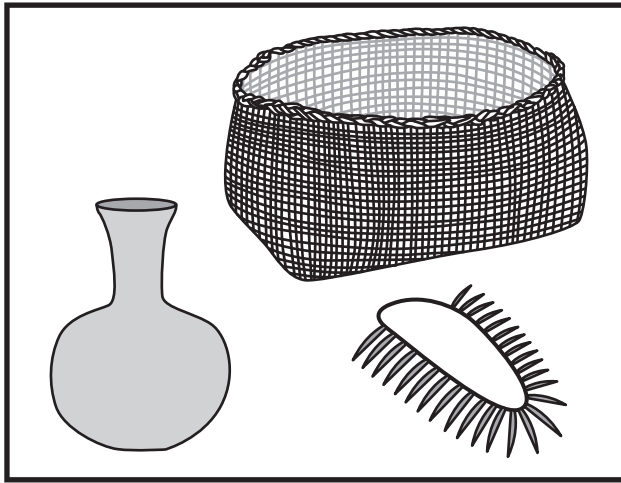

C. Each art piece is different and special.

Would you like to read this part again before you answer the question?

Item 18

We read about the Tunica-Biloxi Pow Wow. We are going to read part of the text again. The word **performance** is in this part. After we read you will choose a sentence that uses the word **performance** correctly.



At the pow wow, there are dancers and singers. Some try to win prizes with their **performance**. They wear special costumes and dance to special music. The costumes have beads and feathers. Many are made with leather and are very colorful.

Point to the bolded word.

Which sentence uses the word **performance** correctly?

Point to each option as the TTS or TA reads each option.

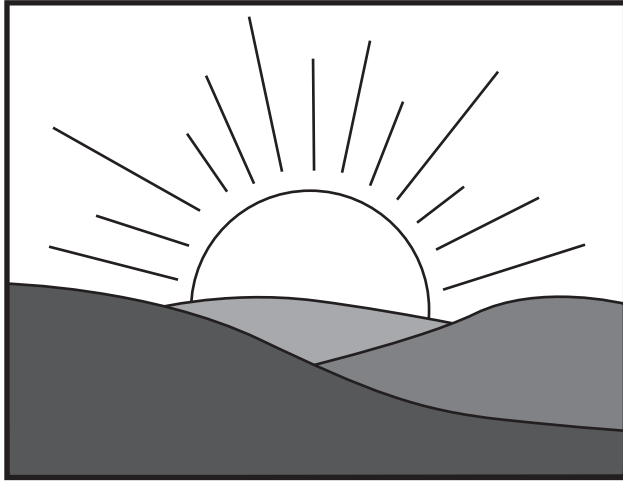

A. In the morning, we will **performance** the round dance.



B. Layla's **performance** of the dance won her first place.



C. I cannot **performance** the dance on my own.

Would you like to read this part again before you answer the question?

You have reached the end of this Session.

You may choose from the following options:

- Review items in this session
- **Pause** this test and **Resume** later
- Complete this session (**End Test**, then **Submit**) and begin Session 2

Session 2

Directions

We are going to read a story about a boy named Luis. After we read, you will be asked questions about the summary.

No Challenge, No Change



Luis runs out of his classroom and down the hall. He sees the sheet of paper posted on the bulletin board. He scans the list, hoping to find his name. The names tell which student will play each part in the school musical. Luis finds his name. He has a part in the musical!

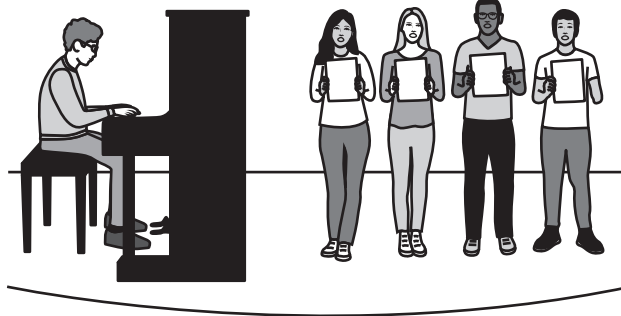

Luis rehearses every day after school. The musical has many songs and dances. At first, everyone uses a script to know what to say and do. But with time and practice, they **memorize** their parts. They do not need to use a script. The students improve as they prepare for the musical.



The performance is just a few days away. Luis and his classmates have been working hard. He is feeling excited. Luis's mom comes to talk to him. She tells him she bought tickets to the show for their family. Luis begins to feel nervous. He realizes there will be people coming to see the musical. He is not sure he can perform in front of other people.

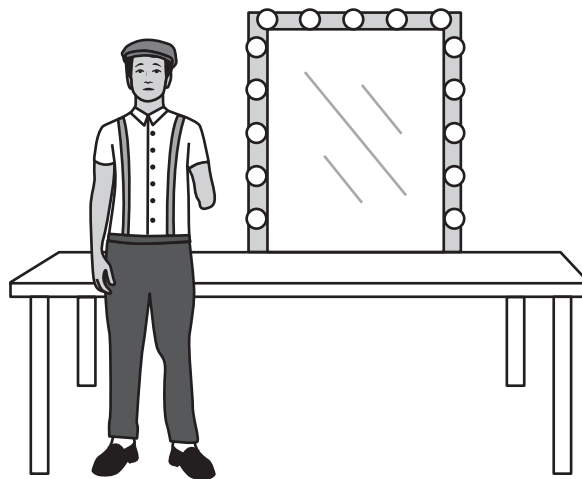

The night of the show arrives. Luis puts on his costume. He knows the words to each song and the steps to each dance. He looks ready, but he still feels nervous.



The students walk onto the stage as the musical begins. Bright lights shine on Luis. He cannot see the audience, but he knows they are there. His legs are shaking and he is sweating. He hears the music start. It is almost time for his song. He takes a deep breath and decides he has to begin his performance.



Luis begins to sing. His voice starts soft but gets louder with each word. He moves around the stage, singing and dancing. He is having fun. At the end of his song, the audience cheers. Luis is proud of himself. He has done something that felt challenging, even while feeling nervous. He proves to himself he can do hard things.

Item 19

Remember a summary should only include information from the story and does not include the reader's opinion.

Which sentence tells what happens at the beginning of the story?

Point to each option as the TTS or TA reads each option.

- A. Luis performs in the school musical.
- B. Luis gets a part in the school musical.
- C. Luis has the best voice in the school musical.

Would you like to read the story again before you answer the question?

Item 20

Which sentence tells what happens in the middle of the story?

Point to each option as the TTS or TA reads each option.

- A. The students learn songs and dances for the show.
- B. The students run the fastest down the hall at school.
- C. The students cheer for each other after the performance.

Would you like to read the story again before you answer the question?

Item 21

Which sentence tells what happens at the end of the story?

Point to each option as the TTS or TA reads each option.

- A. Luis prepares for the school musical.
- B. Luis is the loudest student in the show.
- C. Luis feels proud after doing something challenging.

Would you like to read the story again before you answer the question?

Item 22

We read about a boy named Luis. We are going to read part of the story again. Then you will be asked a question about what Luis's mom does.



The performance is just a few days away. Luis and his classmates have been working hard. He is feeling excited. Luis's mom comes to talk to him. She tells him she bought tickets to the show for their family. Luis begins to feel nervous. He realizes there will be people coming to see the musical. He is not sure he can perform in front of other people.

What does Luis's mom do?

Point to each option as the TTS or TA reads each option.

- A. She begins to feel nervous.
- B. She buys tickets to the show for their family.
- C. She tells Luis the performance is just a few days away.

Would you like to read this part again before you answer the question?

Item 23

We read about a boy named Luis. We are going to read part of the story again. Then you will be asked a question about a detail.



The students walk onto the stage as the musical begins. Bright lights shine on Luis. He cannot see the audience, but he knows they are there. His legs are shaking and he is sweating. He hears the music start. It is almost time for his song. He takes a deep breath and decides he has to begin his performance.

In the story, Luis is nervous at the beginning of the show.

Which detail supports the conclusion that Luis is nervous at the beginning of the show?

Point to each option as the TTS or TA reads each option.

- A. “The students walk onto the stage as the musical begins.”
- B. “His legs are shaking and he is sweating.”
- C. “He hears the music start.”

Would you like to read this part again before you answer the question?

Item 24

We read about a boy named Luis. We are going to read part of the story again. Listen for clues that tell you what the word **memorize** means.

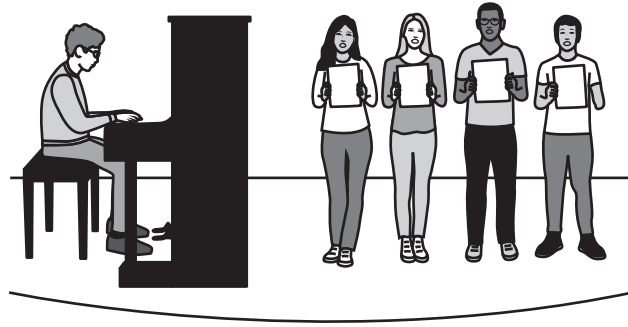

Luis rehearses every day after school. The musical has many songs and dances. At first, everyone uses a script to know what to say and do. But with time and practice, they **memorize** their parts. They do not need to use a script. The students improve as they prepare for the musical.

Point to the bolded word.

What does the word **memorize** mean in this sentence?

Point to each option as the TTS or TA reads each option.

- A. write a musical with songs and dances
- B. spend time at school with other students
- C. remember something without looking at it

Would you like to read this part again before you answer the question?

You have reached the end of this Session.

You may choose from the following options:

- Review items in this session
- **Pause** this test and **Resume** later
- Complete this session (**End Test**, then **Submit**) and begin Session 3

Session 3

Item 25

Here are two sets of events.

You will pick the set of events that is in the correct order.

Which set of events is in the correct order?

Point to each option as the TTS or TA reads each option.



A. Jaime ties his shoes. Jaime puts on his socks. Jaime finds his shoes.



B. Jaime finds his shoes. Jaime puts on his socks. Jaime ties his shoes.

Would you like to read this again before you answer the question?

Item 26

We are going to read a story about a girl named Claudia. After we read, you will pick a sentence that tells what happens next in the story.

First, Claudia comes home from school. Next, she changes clothes.

Remember writers use words to show the order that events happen in stories.

Which sentence tells what happens next in the story?

Point to each option as the TTS or TA reads each option.

- A. Last, she does her homework.
- B. So far, she does her homework.
- C. Tuesday, she did her homework.

Would you like to read this again before you answer the question?

Item 27

We are going to read a story about a person named Jay. After we read, you will pick a sentence that tells what happens next in the story.

Jay digs a hole in the dirt. He drops seeds in the hole. He places dirt over the seeds. He picks up the hose.

Remember, writers include events that happen in order in their stories.

Which event comes next in this story?

Point to each option as the TTS or TA reads each option.

- A. Jay goes for a walk.
- B. Jay makes a sandwich.
- C. Jay waters the ground.

Would you like to read this again before you answer the question?

Item 28

We are going to read a story. After we read, you will pick a sentence that tells what happens next in the story.

Marie wakes up early to go to work at a hotel. At work, she cleans rooms and makes beds. Next, Marie meets some friends and eats lunch.

Which sentence tells what happens next in this story?

Point to each option as the TTS or TA reads each option.

- A. First, Marie goes home.
- B. Finally, Marie goes home.
- C. Earlier, Marie goes home.

Would you like to read this again before you answer the question?

Item 29

This is the first item of a five-part item. Student may not return to this item after responding to this item.

Place Writing Stimulus 1, “Bicycles and Motorcycles” from the Grade 6 Reference Materials and Writing Stimuli at the side of the student’s work space. Use a blank sheet of paper to mask the contents.

You are going to write an essay that compares and contrasts two things.

Remember when we compare, we tell how two things are alike. For example, a crayon

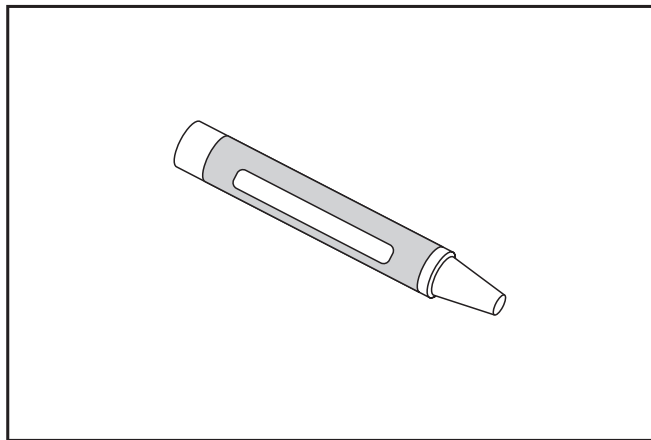

is like a pencil

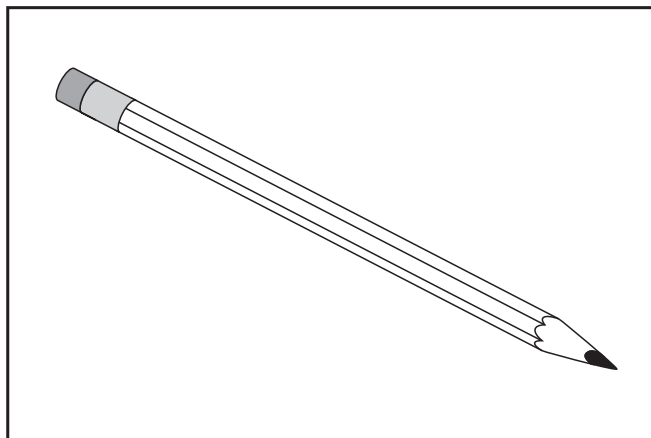

because they are both tools used to write.

When we contrast, we tell how two things are different. The crayon

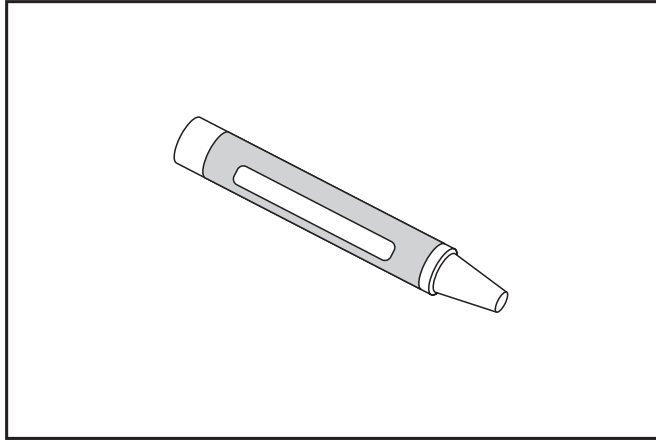

is different from a pencil

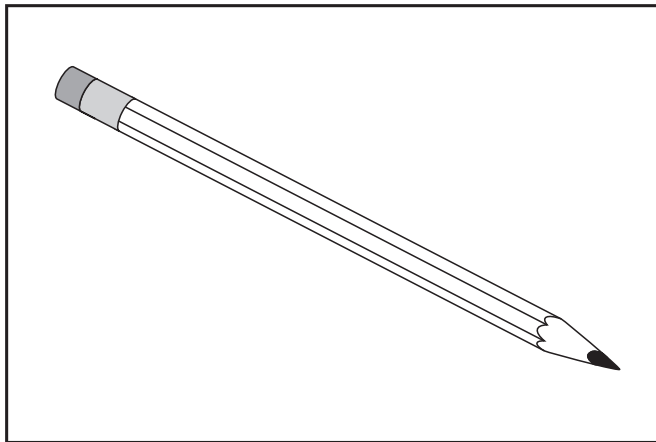

because a crayon is shorter than a pencil.

Which of these compares and contrasts two things?

Point to each option as the TTS or TA reads each option.

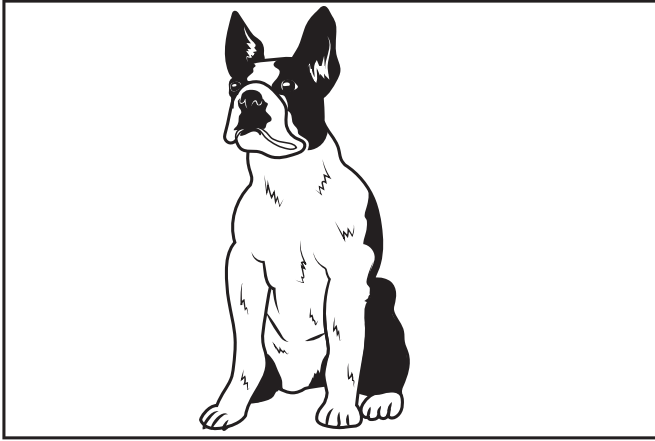

- A. My favorite animal is a dog.

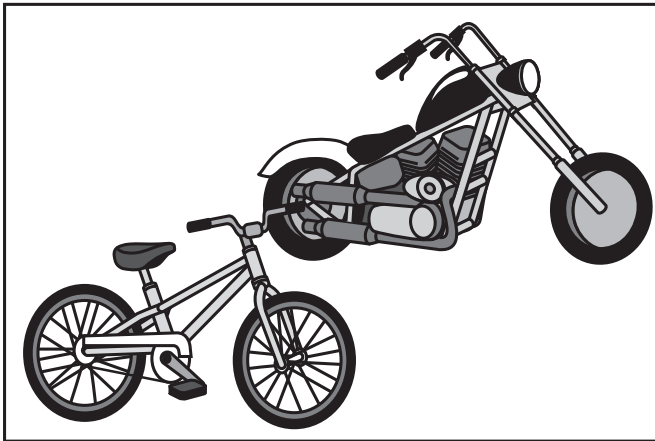

- B. Motorcycles are like bicycles because they both have two wheels.
Motorcycles are different than bicycles because motorcycles go fast and bicycles go slow.

This is the first item of a five-part item. Student may not return to this item after responding to this item.

Item 30

This is the second item of a five-part item. Student may not return to the previous item after responding to this item.

Sentences that compare and contrast two things are: Motorcycles are like bicycles because they both have two wheels. Motorcycles are different than bicycles because motorcycles go fast and bicycles go slow.

Choose the sentence for the beginning of your essay. This will be your introduction. Remember, your introduction should tell you what you will compare and contrast.

Which sentence tells what you will compare and contrast?

Point to each option as the TTS or TA reads each option.

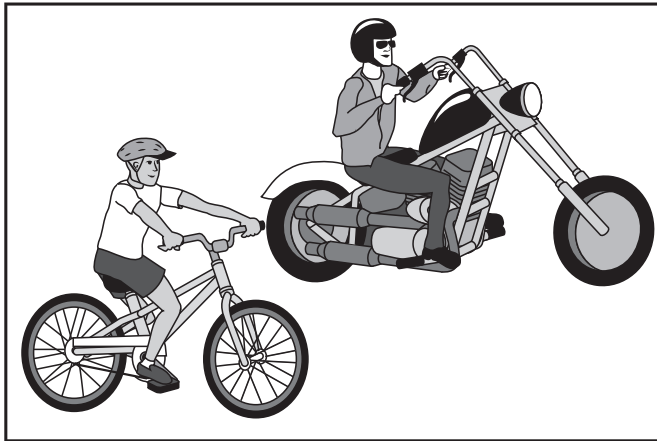

- A. In this essay, I will tell you how motorcycles and bicycles are alike and how they are different.

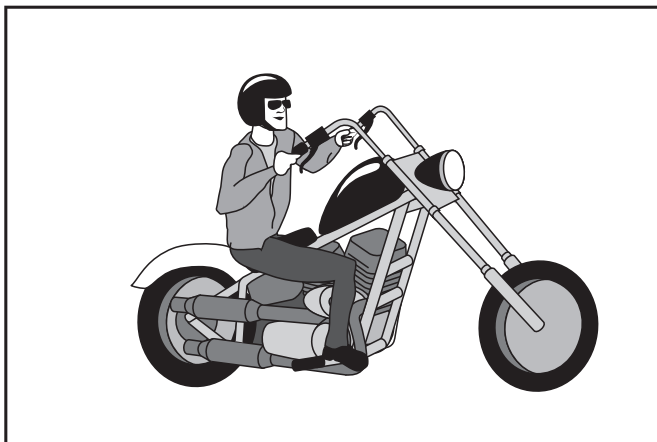

- B. In this essay, I will tell you about motorcycles.

This is the second item of a five-part item. Student may not return to this item after responding to this item.

Item 31

This is the third item of a five-part item. Student may not return to the previous item after responding to this item.

Point to Writing Stimulus 1 “Bicycles and Motorcycles” from the Grade 6 Reference Materials and Writing Stimuli. Unmask the first sentence of text as the TTS or TA reads the following statement.

Your introduction is, “In this essay, I will tell you how motorcycles and bicycles are alike and how they are different.”

Choose a sentence for the body of your essay that tells how motorcycles and bicycles are ALIKE.

Point to each option as the TTS or TA reads each option.

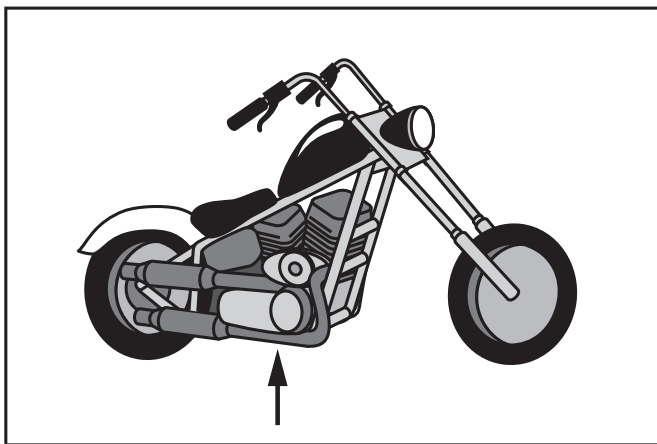

A. Motorcycles have an engine.

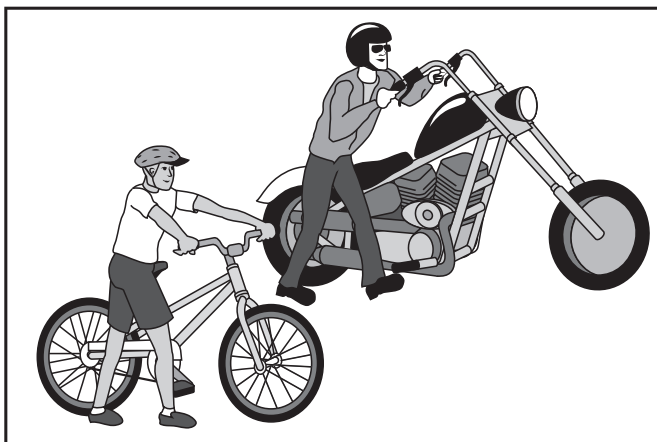

B. Motorcycles and bicycles are used by people.

This is the third item of a five-part item. Student may not return to this item after responding to this item.

Item 32

This is the fourth item of a five-part item. Student may not return to the previous item after responding to this item.

Point to Writing Stimulus 1 “Bicycles and Motorcycles” from the Grade 6 Reference Materials and Writing Stimuli. Unmask the second and third sentences of text as the TTS or TA reads the following statements:

The sentence that tells how motorcycles and bicycles are alike is, “Motorcycles and bicycles are used by people.”

This is a sentence for the body of your essay that tells how motorcycles and bicycles are DIFFERENT.

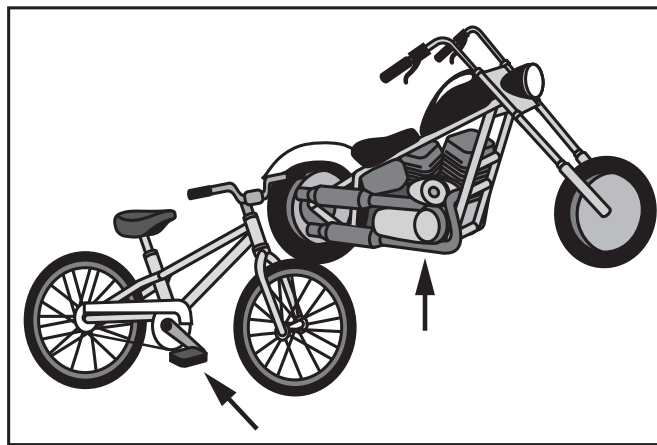

Motorcycles use an engine to move, but bicycles use pedal power.

The sentence that tells how motorcycles and bicycles are different is, “Motorcycles use an engine to move, but bicycles use pedal power.”

Precise words and details help readers imagine the words in their minds. For example, “The big, happy dog” has more precise words and details than “The dog.”

Choose the sentence that uses precise words and details to help readers imagine the words in their minds.

Point to each option as the TTS or TA reads each option.

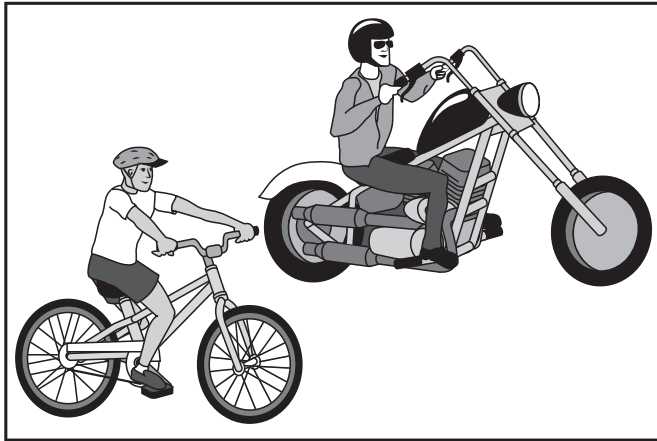

A. Motorcycles and bicycles are fun.

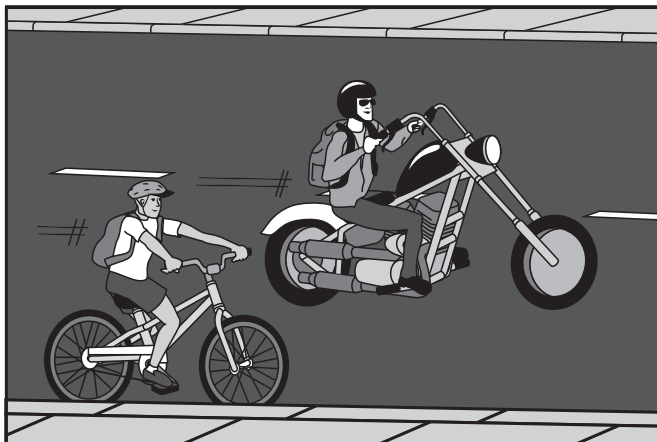

B. Motorcycles and bicycles both have two wheels and help people go places.

This is the fourth item of a five-part item. Student may not return to this item after responding to this item.

Item 33

This is the fifth item of a five-part item. Student may not return to the previous item after responding to this item.

Point to Writing Stimulus 1, “Bicycles and Motorcycles” from the Grade 6 Reference Materials and Writing Stimuli. Unmask the fourth sentence of text as the TTS or TA reads the following statement:

The sentence that uses precise words and details to help readers imagine how motorcycles and bicycles work is, “Motorcycles and bicycles both have two wheels and help people go places.”

You will choose a sentence for the conclusion. Remember, a conclusion tells what the essay was about.

Choose a conclusion to end your essay that compares and contrasts motorcycles and bicycles.

Point to each option as the TTS or TA reads each option.

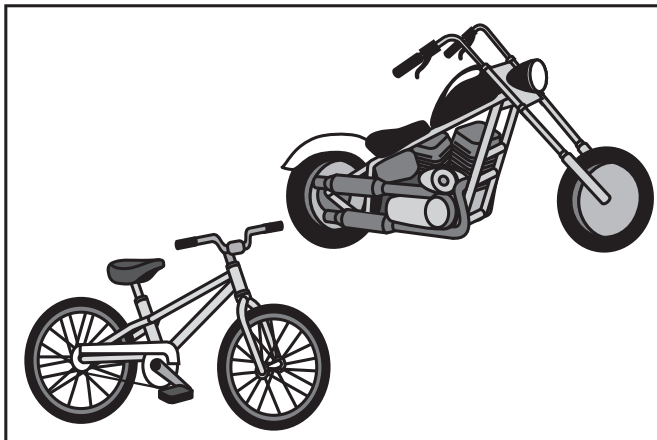

- A. In conclusion, motorcycles and bicycles are alike in some ways but are different in other ways.

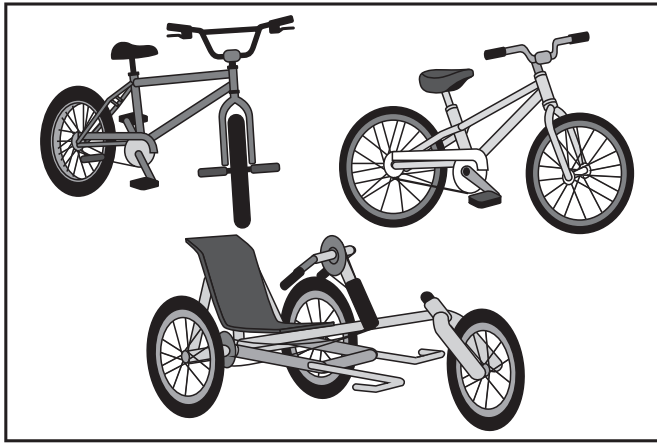

B. In conclusion, there are many types of bicycles.

Wait for student response.

The conclusion that compares and contrasts motorcycles and bicycles is, “In conclusion, motorcycles and bicycles are alike in some ways but different in other ways.”

Now, I will read your essay to you.

Point to Writing Stimulus 1, “Bicycles and Motorcycles” from the Grade 6 Reference Materials and Writing Stimuli. Unmask all sentences of text and say the following statement:

In this essay, I will tell you how motorcycles and bicycles are alike and how they are different. Motorcycles and bicycles are used by people. Motorcycles use an engine to move, but bicycles use pedal power. Motorcycles and bicycles both have two wheels and help people go places. In conclusion, motorcycles and bicycles are alike in some ways but are different in other ways.

You have reached the end of this Session.

You may choose from the following options:

- Review items in this session
- **Pause** this test and **Resume** later
- Complete this session (**End Test**, then **Submit**) and begin Session 4

Session 4

Gather the Writing Stimulus 2, "Indoor and Outdoor Activities" materials and turn to page XXX to begin practice test administration. The stimulus materials can be found in the Grade 6 ELA Practice Test Reference Materials and Writing Stimuli provided by the School Test Coordinator.

Grade 6 Stimulus Materials List for Writing Stimulus 2: "Indoor and Outdoor Activities"

Card 1a: Graphic Organizer Compare/Contrast

Card 2a: eat in the kitchen

Card 3a: brush teeth

Card 4a: go fishing

Card 5a: take a walk

Card 6a: listen to a book

Card 7a: talk to friends

Card 8a: The little dog likes to take walks in the park.

Card 9a-10a: Response Template

Card 11a: Capital letters, end punctuation, and complete sentences

Item 34

Directions

You are going to write an essay that compares and contrasts indoor and outdoor activities.

Present Card 1a: Graphic Organizer Compare/Contrast.

First, you will plan your essay here.

At this stage of the item administration, the TA will work with the student using the printed stimulus material provided by the School Test Coordinator. If the student will enter the response in the DRC INSIGHT Assessment System, the student may type in the response areas on the screen instead of writing on Cards 9a and 10a.

Move Card 1a out of view of the student. Present and point to Cards 9a and 10a or the computer screen.

Next, you will write your essay here.

Last, you will revise and edit your essay.

Move Cards 9a and 10a out of view of the student.

Comparing means showing how two things are alike. For example, one way cats and dogs are alike is that they are both pets. Contrasting means showing how two things are different. One way cats and dogs are different is that cats meow and dogs bark. In your essay, you will compare and contrast activities that people do indoors and outdoors.

Selection of Activities

Present Card 1a. Point to Card 1a as you say the following statement.

You can use this graphic organizer to plan what you will write. The topic is to compare and contrast activities people do indoors and outdoors.

Write one activity that people can do indoors here.

Point to the space for "Indoor Activity" in the column on the left side of Card 1a.

If the student PROVIDES a relevant activity, go to “Outdoor Activity” prompt.

If the student DOES NOT PROVIDE an activity people might do indoors, present Cards 2a and 3a. Say the following statement:

Here are activities that people might do indoors. You need to pick one activity people might do indoors.

Point to and read each of the activities.

eat in the kitchen

brush teeth

Remove the unselected activity. Place the selected activity at the top left of the workspace where the student can refer to it and write the selected activity in the space for “Indoor Activity” in the column on the left side of Card 1a.

NOTE: If the student does not select an activity, select one of the two provided activities to which the student can provide details. If you select the activity, say the following statement:

You need an activity that people might do indoors. I will add [Activity] to your graphic organizer.

Write the selected activity in the corresponding space on Card 1a. Remove Cards 2a and 3a.

Write one activity that people might do outdoors here.

Point to the space for “Outdoor Activity” in the column on the right side of Card 1a.

If the student PROVIDES a relevant activity, go to “Indoor and Outdoor Activity” prompt.

If the student DOES NOT PROVIDE an activity that people might do outdoors, present Cards 4a and 5a. Say the following statement:

Here are activities that people might do outdoors. You need to pick one activity.

Point to and read each of the activities.

Which activity would you like to write about? Pick one activity that people might do outdoors.

Point to and read each activity to the student.

go fishing

take a walk

Remove the unselected activity. Place the selected activity at the top left of the work space where the student can refer to it and write the selected activity in the space for “Outdoor Activity” in the column on the right side of Card 1a.

NOTE: If the student does not select an activity, select one of the two provided activities to which the student can provide details. If you select the activity, say the following statement:

You need an activity that people might do outdoors. I will add [Activity] to your graphic organizer.

Write the selected activity in the corresponding space on Card 1a. Remove Cards 4a and 5a.

Write one activity that people might do indoors and outdoors here.

Point to the space for “Indoor and Outdoor Activity” in the middle column of Card 1a.

*If the student PROVIDES a relevant activity, go to **Details** step.*

If the student DOES NOT PROVIDE an activity that people might do indoors and outdoors, present Cards 6a and 7a. Say the following statement:

Here are activities that people might do indoors and outdoors. You need to pick one activity.

Point to and read each of the activities.

listen to a book

talk to friends

Remove the unselected activity. Place the selected activity at the top left of the workspace where the student can refer to it and write the selected activity in the space for “Indoor and Outdoor Activity” in the column in the center of Card 1a.

NOTE: If the student does not select an activity, select one of the two provided activities to which the student can provide details. If you select the activity, say the following statement:

You need an activity that people might do indoors and outdoors. I will add [Activity] to your graphic organizer.

Write the selected activity in the corresponding space on Card 1a. Remove Cards 6a and 7a.

Details

Point to Card 1a.

Now that you have picked the activities people might do indoors and outdoors, you can add more information about them.

Present Card 8a.

Listen to this sentence: “The little dog likes to take walks in the park.”

The detail “little dog” tells the reader about the dog. The detail “in the park” makes it easier to picture a place. Using details makes your writing clear. When you write, remember to use details to describe the activities.

Remove Card 8a. Point to the “Indoor Activity” column on Card 1a.

You chose [Indoor Activity] as something people might do indoors. Add details about [Indoor Activity] here.

Point to the space for “Details” in the “Indoor Activity” column on the left of Card 1a.

You chose [Outdoor Activity] as something people might do outdoors.

Now, add details about [Outdoor Activity] here.

Point to the space for “Details” in the “Outdoor Activity” column on the right of Card 1a.

You chose [Indoor and Outdoor Activity] as something people might do both indoors and outdoors. Now, add details about [Indoor and Outdoor Activity] here.

Point to the space for “Details” in the “Indoor and Outdoor Activity” column in the middle of Card 1a.

Move Card 1a to the side where the student can refer to it.

Introduction

Present Card 9a or the computer screen.

Now that you have planned your compare and contrast essay, you will use your notes and this response template to help you write the introduction.

Remember, you will compare and contrast activities people might do indoors and activities people might do outdoors.

Remove Card 9a and present Card 11a. Cover the row showing the examples of capital letters. Point to each punctuation mark as you read the following statement:

Good writing uses a period, exclamation point, or question mark at the end of each complete sentence.

Point to “Good writers use complete sentences.”

Good writers use complete sentences.

Remember to write complete sentences,

Point to the period in “Good writers use complete sentences.”

and to use correct punctuation.

Move Card 11a to the side so that the student can refer to it when writing. Present Card 9a or the computer screen.

You will use your notes to help you write your essay.

Indicate Card 1a and the topic.

Remember, your introduction states that your essay is about comparing and contrasting activities people might do indoors and activities people might do outdoors. You can use your notes to help you write your essay here.

Point to the space after the first sentence starter on Card 9a or the computer screen. Read the sentence starter using an upward inflection in your voice at the end to indicate that it is not a complete sentence.

The introduction is started for you. Finish this sentence.

Point to the lines after the first sentence starter on Card 9a or the computer screen.

In this essay, I will compare and contrast _____

Now, I will read the introduction of your compare and contrast essay to you.

Read aloud the introduction the student has written.

Body

Point to Card 1a.

Next, you will write the body of your essay. Use the notes from your graphic organizer about comparing and contrasting activities people might do indoors and activities people might do outdoors.

First, write an activity people might do indoors.

Point to Card 1a. Point to the “Indoor Activity” column on Card 1a and the student’s selected activity.

Use your notes to finish this sentence.

Read the second sentence starter on Card 9a, or the computer screen, using an upward inflection in your voice at the end to indicate that it is not a complete sentence.

When indoors, _____

Now, I will write your activity in the beginning of the next sentence and read it to you.

Point to the third sentence starter on Card 9a, or the computer screen, and read the sentence starter using an upward inflection in your voice at the end to indicate that it is not a complete sentence.

When people [Indoor Activity], they _____

Look at your notes from the graphic organizer. Use the details that you wrote about [Indoor Activity] to finish this sentence. I will read your notes to you.

Read all student notes in the “Details” section of the “Indoor Activity” column on Card 1a.

Point to the third sentence starter on Card 9a, or the computer screen, and read the sentence starter using an upward inflection in your voice at the end to indicate that it is not a complete sentence.

When people [Indoor Activity], they _____

Next, you will write about an activity people might do outdoors. I will read your notes to you.

Point to Card 1a. Point to the “Outdoor Activity” column on Card 1a and the student’s selected activity.

Use your notes to finish this sentence.

Read the fourth sentence starter on Card 9a, or the computer screen, using an upward inflection in your voice at the end to indicate that it is not a complete sentence.

When outdoors, _____

Now, I will write your activity in the beginning of the next sentence and read it to you.

Point to the first sentence starter on Card 10a, or the fifth sentence starter on the computer screen, and read the sentence starter using an upward inflection in your voice at the end to indicate that it is not a complete sentence.

When people [Outdoor Activity], they _____

Look at the notes from the graphic organizer. Use the details that you wrote about [Outdoor Activity] to finish this sentence. I will read your notes to you.

Read all student notes in the “Details” section of the “Outdoor Activity” column on Card 1a.

Read the first sentence starter on Card 10a, or the fifth sentence starter on the computer screen, using an upward inflection in your voice at the end to indicate that it is not a complete sentence.

When people [Outdoor Activity], they _____

You chose [Indoor and Outdoor Activity] as something that people might do indoors and outdoors. I will read your notes to you.

Point to the “Indoor and Outdoor” column on Card 1a and the student’s selected activity.

Use your notes to finish this sentence.

Point to the second sentence starter on Card 10a, or the sixth sentence starter on the computer screen, and read the sentence starter using an upward inflection in your voice at the end to indicate that it is not a complete sentence.

When indoors and outdoors, _____

Now, I will write your activity in the beginning of the next sentence and read it to you.

Point to the third sentence starter on Card 10a, or the seventh sentence starter on the computer screen, and read the sentence starter using an upward inflection in your voice at the end to indicate that it is not a complete sentence.

When people [Indoor and Outdoor Activity], they _____

Look at your graphic organizer. Use the details that you wrote about [Indoor and Outdoor Activity] to finish this sentence. I will read your notes to you.

Read all student notes in the “Details” section of the “Indoor and Outdoor Activity” column on Card 1a.

Read the third sentence starter on Card 10a, or the seventh sentence starter on the computer screen, using an upward inflection in your voice at the end to indicate that it is not a complete sentence.

When people [Indoor and Outdoor Activity], they _____

Conclusion

I will read what you have already written. Then you will write your conclusion.

Point to and read Cards 9a and 10a or the computer screen.

Remember, a conclusion restates the topic of your essay which is about comparing and contrasting activities people might do indoors and outdoors.

The conclusion is started for you.

Point to the sentence starter on Card 10a or the computer screen.

Finish this sentence.

Point to the sentence starter and read the sentence starter using an upward inflection in your voice at the end to indicate that it is not a complete sentence.

In conclusion, _____

Revising

Now, I will read your compare and contrast essay. Then, you can revise your essay.

Point to and read all parts of Cards 9a and 10a or the computer screen.

Introduction

I will read the introduction of your essay to you.

Read the student's Introduction on Card 9a or the computer screen.

Present Card 1a. Point to the "Topic" on Card 1a.

You can use your notes as a checklist to be sure you included everything in the introduction of your essay.

Start with the introduction of your essay. You can revise the introduction.

Point to the student's Introduction on Card 9a or the computer screen.

Is there anything you want to revise about how you state that your essay is about comparing and contrasting activities people might do indoors and outdoors?

*If the student INDICATES NO, move to the **Body**.*

If the student INDICATES revisions, ask the student to write the revisions on Card 9a or the computer screen.

Again, point to the first sentence(s) on Card 9a or the computer screen.

Make revisions to your introduction about comparing and contrasting activities people might do indoors and outdoors.

Body

Next, you can make revisions to the body of your essay. I will read the body of your essay to you.

Point to the student's body on Card 9a or the computer screen. Point to and read the second and third sentence starters "When indoors, [Indoor Activity]. When people [Indoor Activity], they _____" in the "Body" section of Card 9a or the computer screen.

You can use your notes as a checklist to be sure you included everything in the body of your essay. Remember you were to use details to describe something people can do indoors. I will read what you wrote.

Present Card 1a. Point to the "Indoor Activity" column on Card 1a.

Is there anything you want to revise about activities people might do indoors?

If the student INDICATES NO revisions, move to the next question.

If the student INDICATES revisions, ask the student to write the revisions on Card 9a or the computer screen.

Make your revisions here.

Point to the second and third sentence in the “Body” section of Card 9a or the computer screen.

You were asked to use details to describe something people might do outdoors. I will read what you wrote.

Point to and read the fourth and fifth sentence starters “When outdoors, [Outdoor Activity], When people [Outdoor Activity], they _____” in the “Body” section of Cards 9a and 10a or the computer screen.

You can use your notes as a checklist to be sure you included everything in the body of your essay.

Present Card 1a. Point to the “Outdoor Activity” column on Card 1a.

Is there anything you want to revise about what people might do outdoors?

If the student INDICATES NO revisions, move to the next question.

If the student INDICATES revisions, ask the student to write the revisions on Cards 9a and 10a or the computer screen.

Make your revisions here.

Point to the fourth and fifth sentence starters in the “Body” section of Cards 9a and 10a or the computer screen.

You were asked to use details to tell about something people might do indoors and outdoors. I will read what you wrote.

Point to and read the sixth and seventh sentence starters “When indoors and outdoors” [Indoor and Outdoor Activity]. When people [Indoor and Outdoor Activity], they _____” in the “Body” section of Cards 9–10a or the computer screen.

You can use your notes to be sure you included everything in the body of your essay.

Present Card 1a. Point to the “Indoor and Outdoor” column on Card 1a.

Is there anything you want to add or change about what people might do indoors and outdoors?

*If the student INDICATES NO revisions, move to the **Conclusion**.*

If the student INDICATES revisions, ask the student to write the revisions or edits on Cards 9–10a or the computer screen.

Make your changes to the body of your essay here.

Point to the sixth and seventh sentence starters in the “Body” section of Cards 9–10a or the computer screen.

Conclusion

Next, you can make revisions to the conclusion of your essay. I will read the conclusion of your essay to you.

Point to and read the student’s “Conclusion” on Card 10a or the computer screen.

You may use your notes to be sure you included everything in the conclusion of your essay.

Present Card 1a. Point to the “Topic” at the top of Card 1a.

Is there anything you want to revise about comparing and contrasting indoor and outdoor activities?

*If the student INDICATES NO revisions, move on to **Editing**.*

If the student INDICATES revisions, ask the student to write the revisions on Card 10a or the computer screen.

Make revisions to the conclusion of your essay here.

Point to the final sentence starter on card 10a or the computer screen.

Editing

Now you can edit your essay.

Present Card 11a. Cover the row showing the examples of capital letters. Point to each punctuation mark as you read the following statement:

Good writing uses a period, exclamation point, or question mark at the end of each complete sentence.

Point to “Good writers use complete sentences.”

Good writers use complete sentences.

Remember to write complete sentences,

Point to the period in “Good writers use complete sentences.”

and use correct punctuation.

Move Card 11a to the side so that the student can refer to it when writing. Present Cards 9a and 10a or the computer screen.

Now you can make edits to your essay.

*If the student DOES NOT INDICATE any edits, move to **Read Essay**.*

If the student INDICATES edits, ask the student to write the edits on Cards 9a and 10a or the computer screen.

Read Essay

Point to Cards 9a and 10a or the computer screen. If the student makes revisions or edits to the essay as it is read, mark the revisions or edits. Only read the essay once. Whatever is typed into the DRC INSIGHT Assessment System will be scored and is the final product.

Now that you have finished making your revisions and edits, I will read your final essay to you.

Read the final essay to the student.

You have reached the end of this Session.

You may choose from the following options:

- Review items in this session
- **Pause** this test and **Resume** later
- Complete this session (**End Test**, then **Submit**)

LEAP CONNECT

Practice Test