

LEAP CONNECT

Practice Test Reference Materials & Writing Stimuli

English Language Arts
Grade 8

Reference Materials include required graphics that are to be presented to the student during administration of the LEAP Connect ELA practice test. Refer to the *Directions for Practice Test Administration* (DPTA) for detailed instructions.

Session 1

Basketball Hall of Fame Answer Options (Items 1–5)

Pistol Pete Answer Options (Items 6–8)

My Kind of Language Answer Options (Items 9–14)

Rice and Crawfish – The Perfect Combination Answer Options (Items 15–19)

Session 2

Up and Away Answer Options (Items 20–25)

Session 3

Answer Options (Items 26–30)

Writing Stimuli 1, “Finding a Book” (Item 31–35)

Finding a Book Answer Options (Items 31–35)

Session 4

After-school Activity Cards 1a–7a

Session 1

Session 1 – Item 1 Answer Options

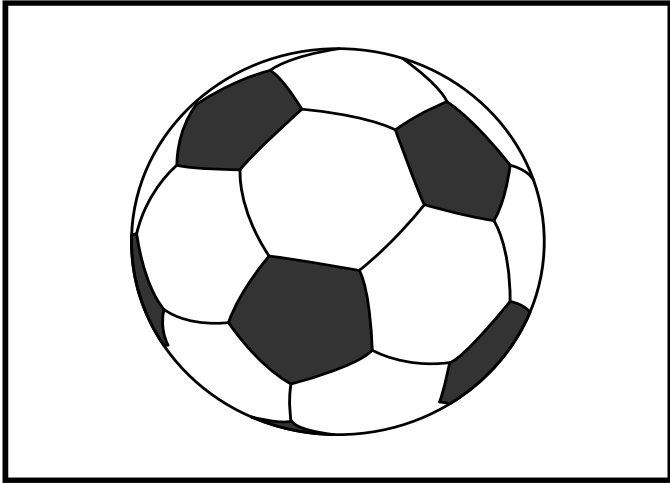

A. soccer

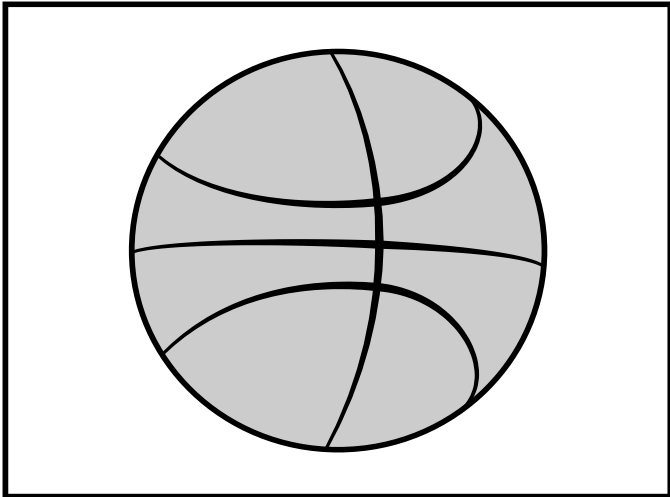

B. basketball

Session 1 – Item 2 Answer Options

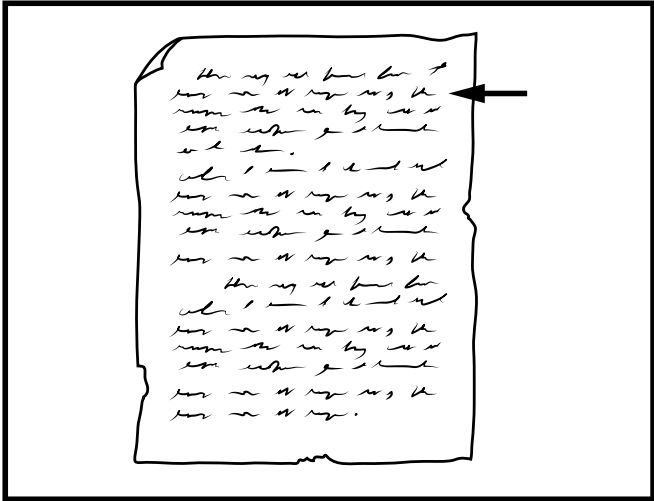

A. the beginning

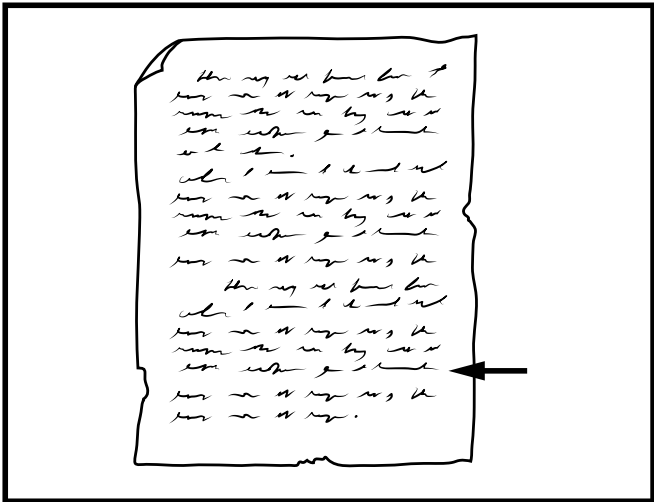

B. the end

Session 1 – Item 3 Answer Options

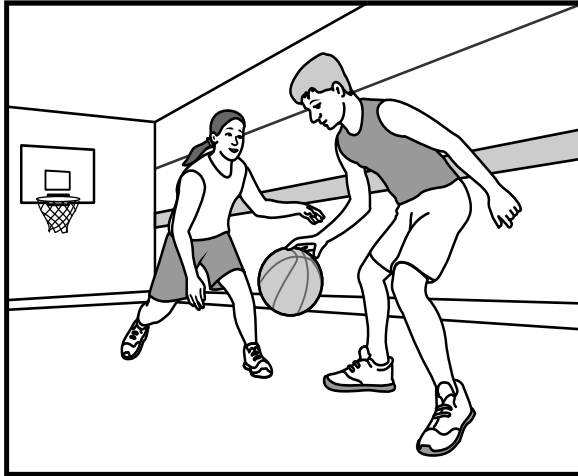

A. People can play basketball there.

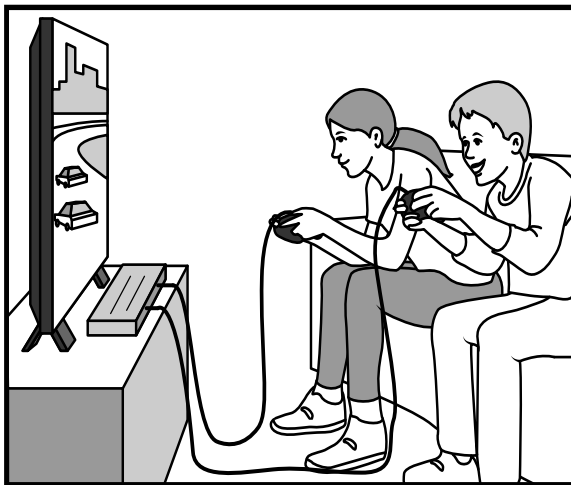

B. People can play video games there.

Session 1 – Item 4 Answer Options

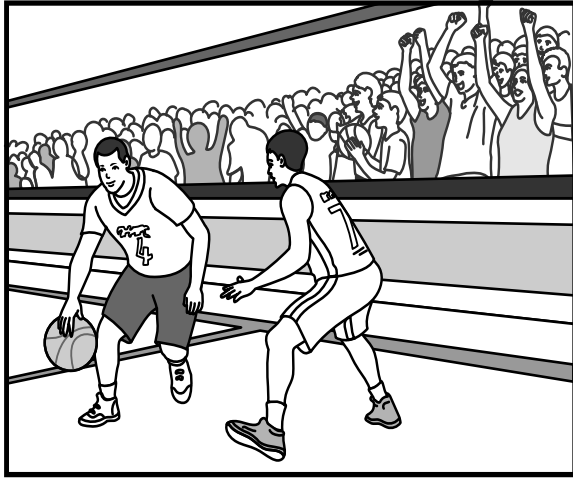

- A. The Basketball Hall of Fame honors its biggest fans.

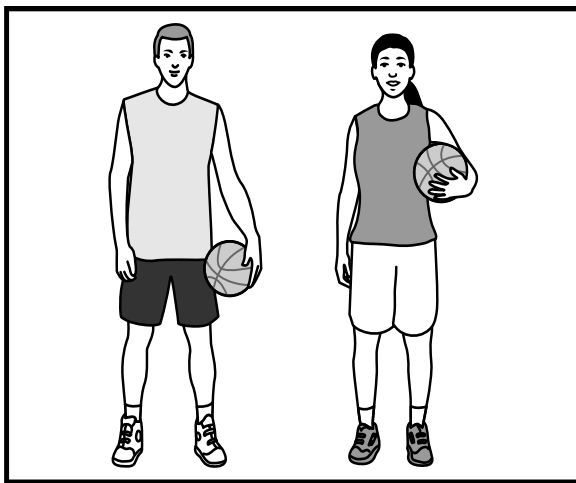

- B. The Basketball Hall of Fame includes both men and women.

Session 1 – Item 5 Answer Options

A. looks the same

B. not like anything else

Session 1 – Item 6 Answer Options

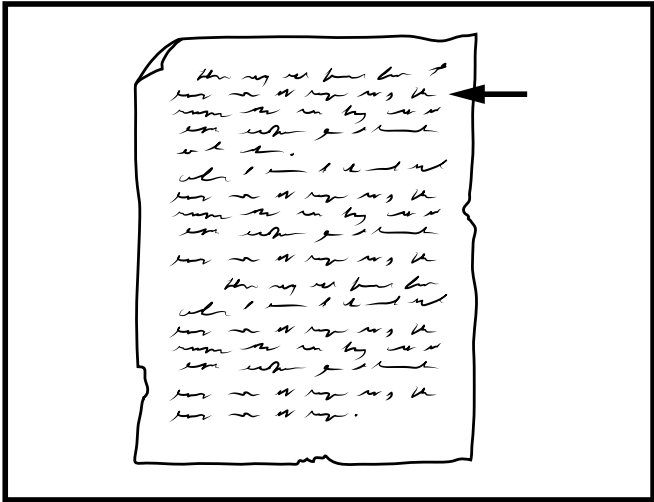

A. the beginning

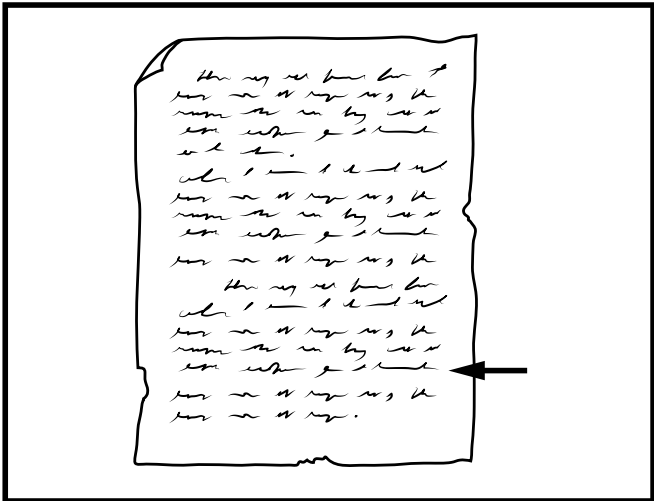

B. the end

Session 1 – Item 7 Answer Options

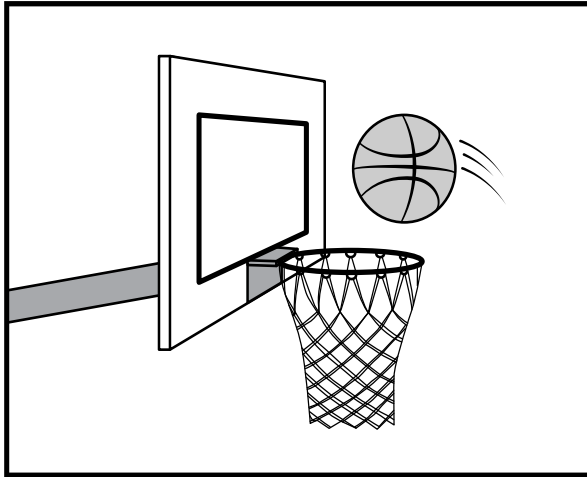

A. Pistol Pete was very good at playing basketball.

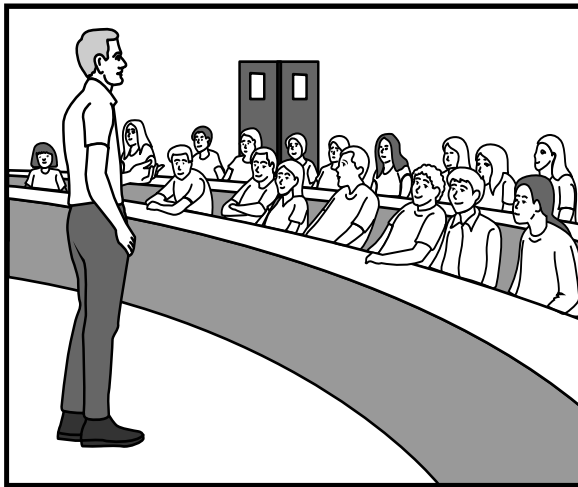

B. Pistol Pete was very good at his college classes.

Session 1 – Item 8 Answer Options



- A. Pistol Pete practiced basketball for hours each day.

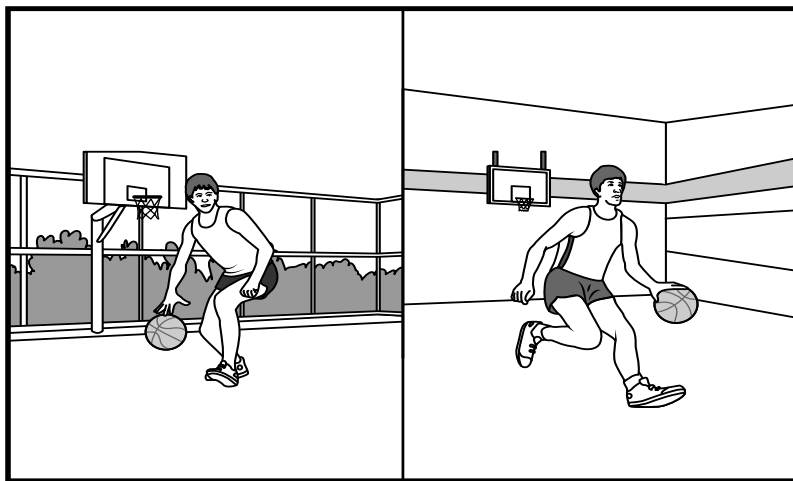

- B. Pistol Pete practiced basketball both inside and outside.

Session 1 – Item 9 Answer Options



A. He plans to practice playing his trumpet a lot.



B. He gets an old trumpet from his dad.



C. He plays in a band with his friends who also play instruments.

Session 1 – Item 10 Answer Options



A. The boy sees three valves on the trumpet.

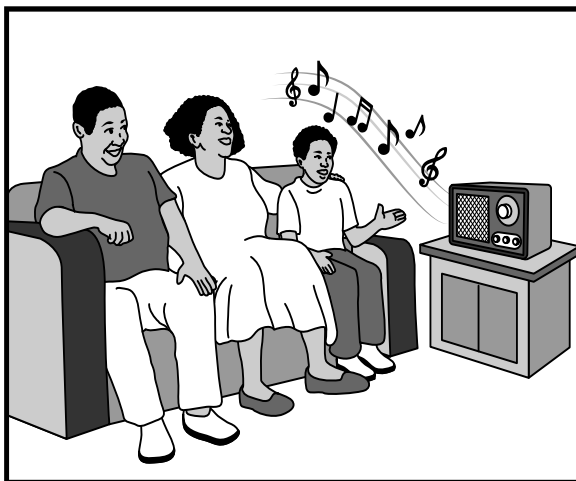

B. The boy loves listening to jazz music with his parents.



C. The boy learns to play different kinds of musical instruments.

Session 1 – Item 11 Answer Options



A. The boy wants to be famous.



B. The boy learns that being a jazz musician is easy.



- C. The boy learns who Louis Armstrong is and wants to be like him.

Session 1 – Item 12 Answer Options



- A. Louis Armstrong's first instrument was a cornet.



- B. Louis Armstrong played his instruments for many years.



C. Louis Armstrong's favorite style of jazz to play was called Dixieland.

Session 1 – Item 13 Answer Options



A. Louis Armstrong buys many instruments.



B. Louis Armstrong is known as the “Father of Jazz.”



- C. Louis Armstrong learns to play not only jazz, but also other styles of music on the trumpet.

Session 1 – Item 14 Answer Options

A. made with two hands

B. played for a short amount of time

C. owned before by someone else

Session 1 - Item 15 Answer Options



A. Crawfish are found in Louisiana.

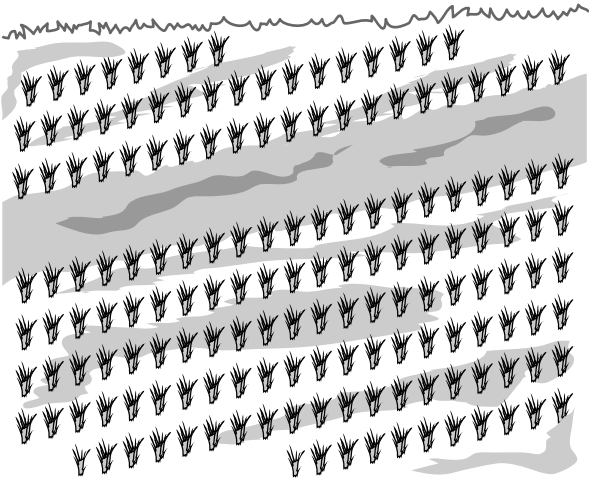

B. Crawfish grow very well in rice ponds.

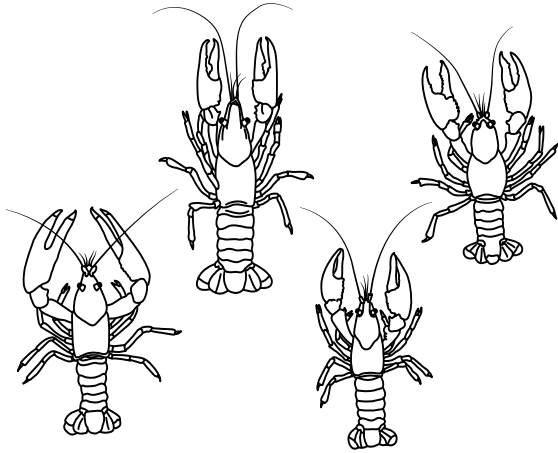

C. Crayfish are classified into different species.

Session 1 - Item 16 Answer Options

- A. It provides maps of where to grow rice for the crawfish.

- B. It provides a diagram showing how to grow rice for crawfish.

- C. It provides information about the weather conditions during the summer.

Session 1 - Item 17 Answer Options

- A. There are two ways for farmers to grow new crawfish.

- B. Unharvested crawfish are crawfish that were stocked the year before.

- C. Farmers flood the rice ponds with water after the rice has been cut.

Session 1 - Item 19 Answer Options

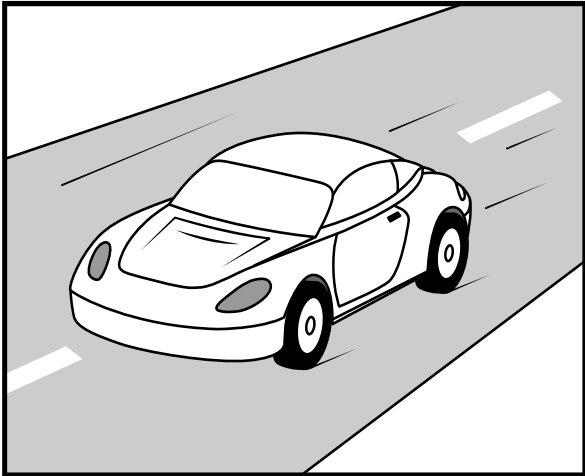

A. The ample car drives fast.



B. The boy wears his ample shirt to school.

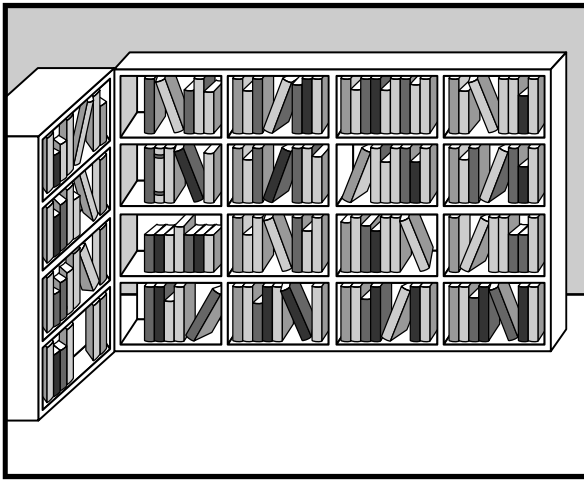

C. The library has an ample number of books to choose from.

Session 2

Session 1 - Item 20 Answer Options



A. Amelia and Felicia work together.



B. Amelia and Felicia ask their teacher for lots of help.



C. Amelia and Felicia collect lots of pennies to buy a drone.

Session 2 – Item 21 Answer Options



A. Amelia worries that she won't know anyone in class.



B. Amelia looks at her class schedule.

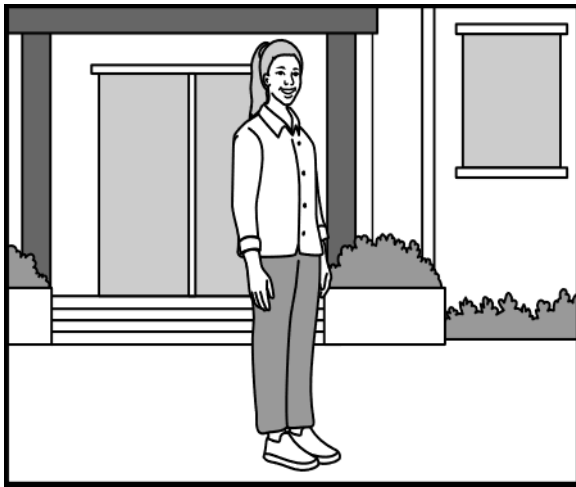

C. Amelia is at school.

Session 2 – Item 22 Answer Options



A. Amelia takes different classes at school.

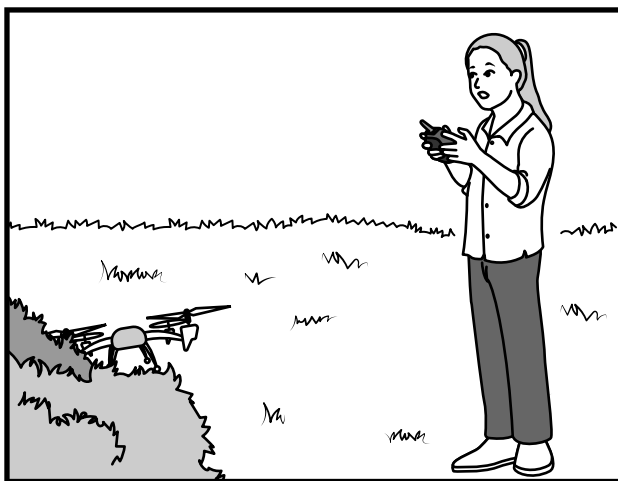

B. Amelia's drone keeps running into the bushes.

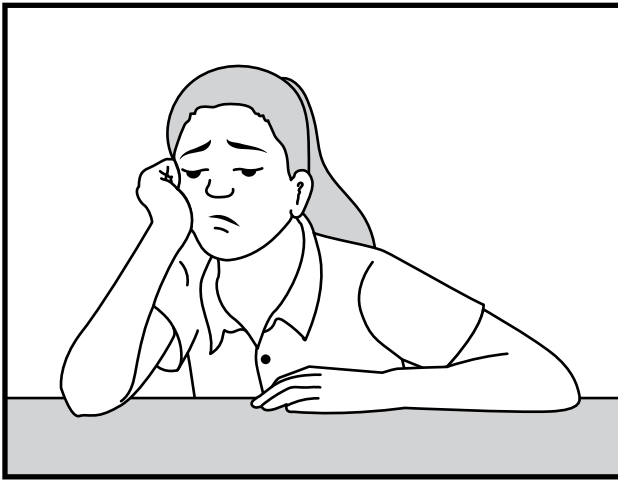

C. Amelia thinks computer class will be boring.

Session 2 – Item 23 Answer Options

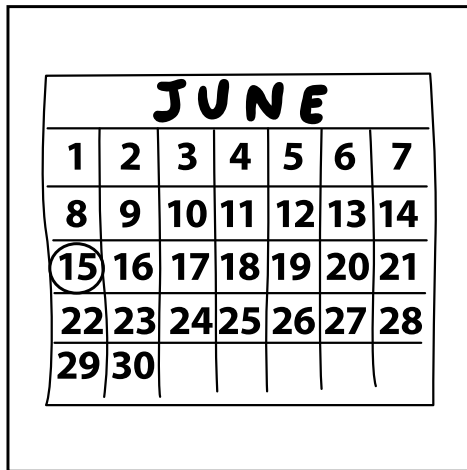

A. It was the day to fly the drone.



B. The class is going to see if their drones can fly.

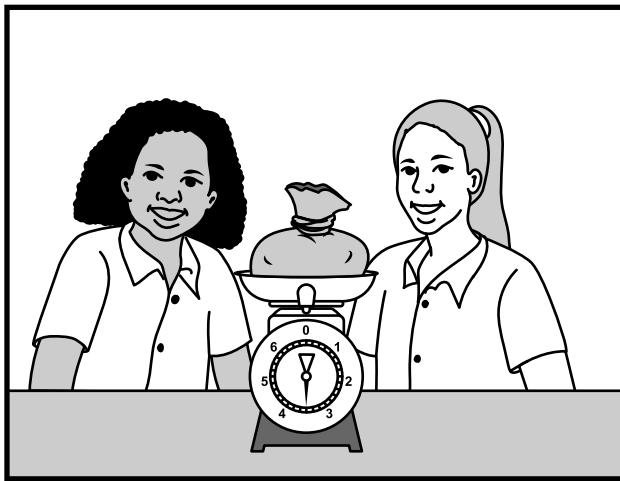

C. Amelia and Felicia work together to weigh the pennies.

Session 2 – Item 24 Answer Options

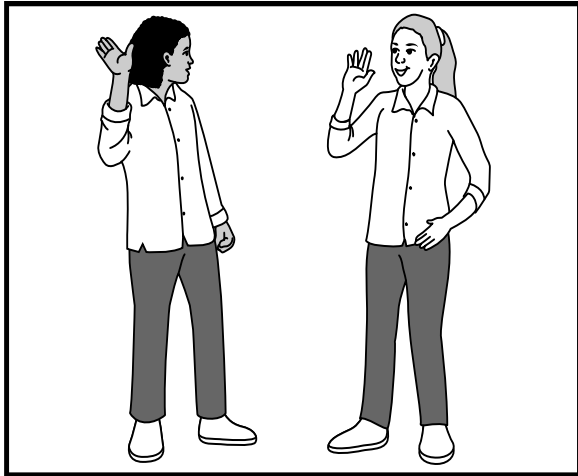

A. Amelia and Felicia wave goodbye to each other.

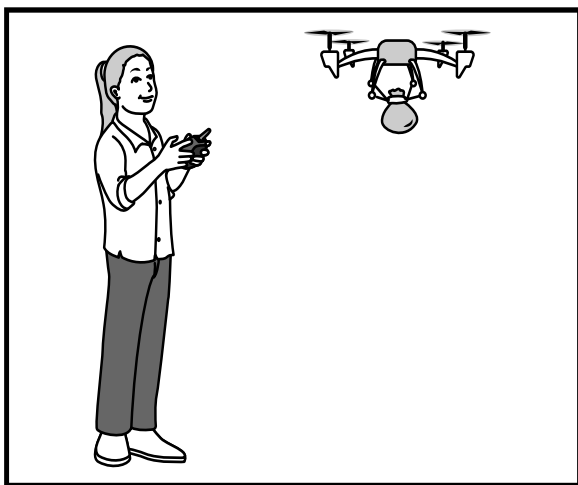

B. Amelia flies the drone across the field to Felicia.

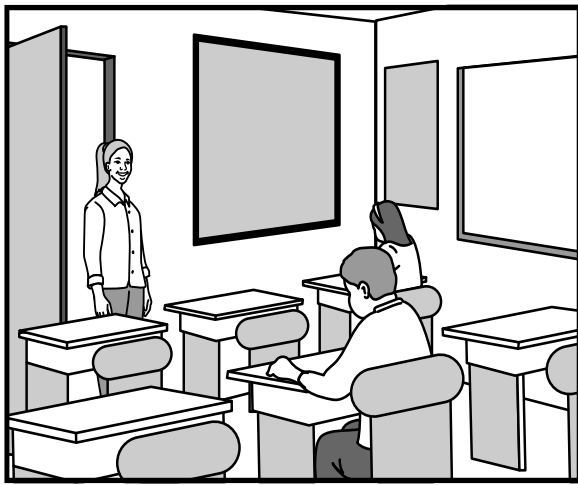

C. Amelia does not know who to sit by in computer class.

Session 2 – Item 25 Answer Options

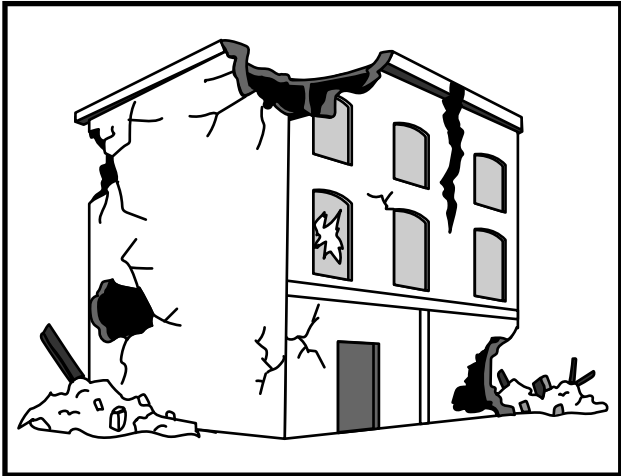

A. to fall down



B. to fasten in place



C. to use a lot of effort

Session 3

Session 3 – Item 26 Answer Options

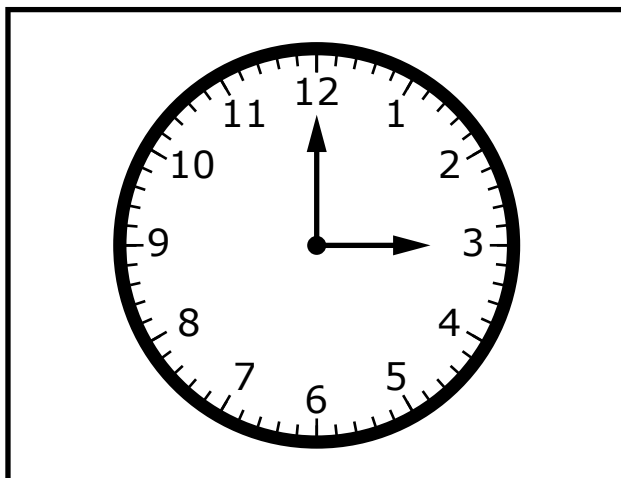

A. a clock

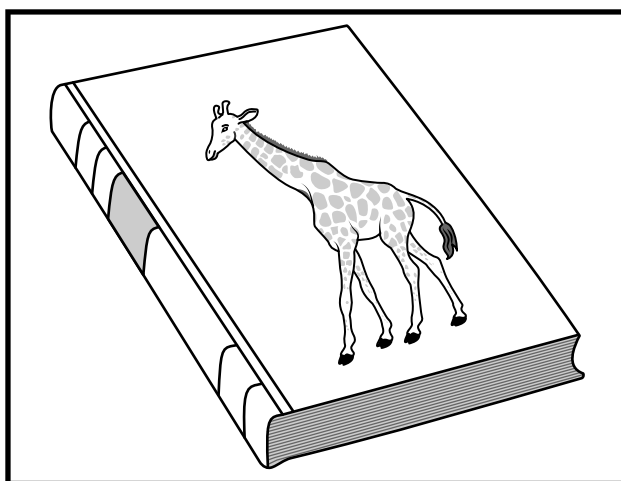

B. a book

Session 3 – Item 27 Answer Options



A. In conclusion, it is important to volunteer to take out the trash.



B. Volunteering is good because it teaches you new skills.

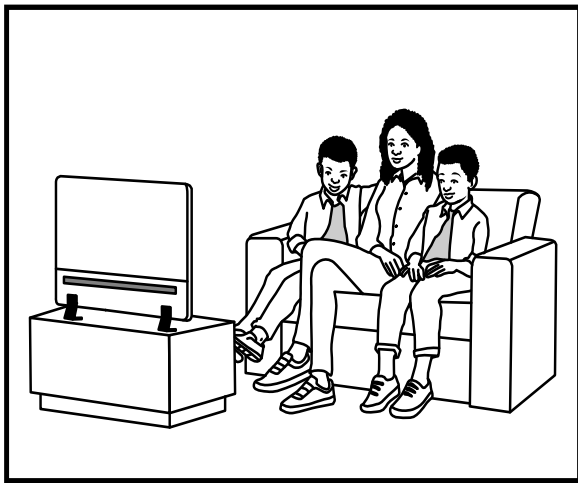

C. Volunteering is bad because there is no time to watch TV.

Session 3 – Item 28 Answer Options

- A. Clubs can teach students how to work with others.

- B. Schools have students from many places.

- C. Students spend many hours in school each year.

Session 3 – Item 29 Answer Options

- A. The first school vending machines were filled with candy.

- B. There are many facts about vending machines in schools.

- C. Healthy choices in school vending machines positively affect students' diets.

Session 3 – Item 30 Answer Options

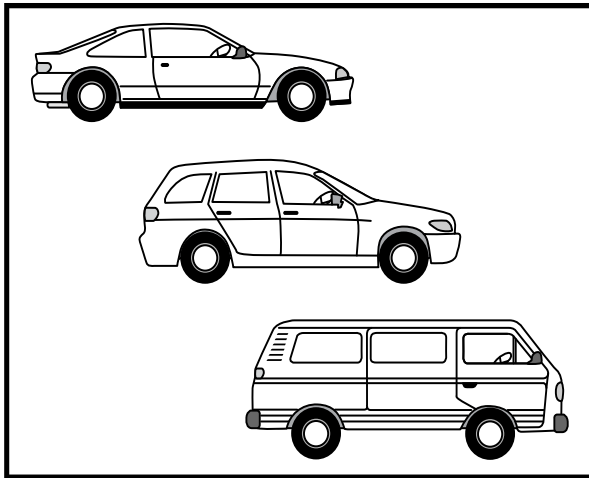

- A. When you look at cars, there are many different sizes and shapes.



- B. When you cannot find a book at the library, a way to solve the problem is to ask for help.

Finding a Book

I will write about a way to solve the problem of not finding a book in the library.

You can ask the librarian for help.

You can tell the librarian the author’s name and title of the book.

If you cannot find a book in the library, then try searching for the author’s name on the computer.

In conclusion, there are many ways to find a book in the library.

Session 3 – Item 31 Answer Options

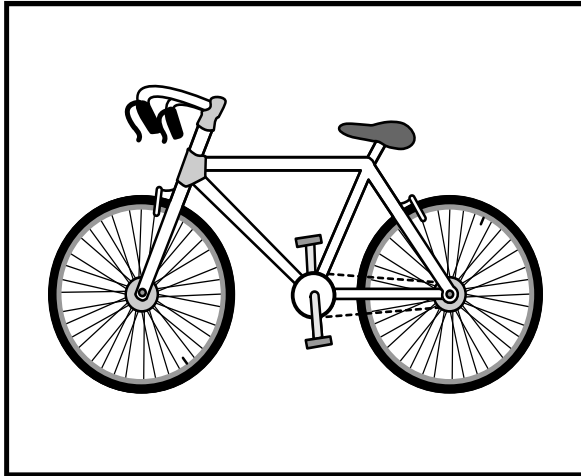

A. I will write about how to ride a bicycle.

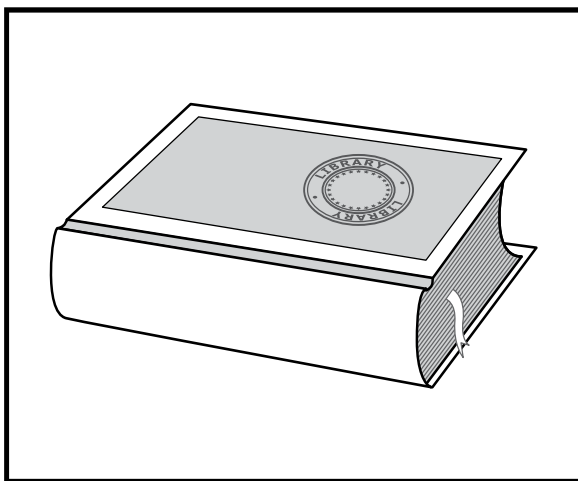

B. I will write about a way to solve the problem of not finding a book in the library.

Session 3 – Item 32 Answer Options

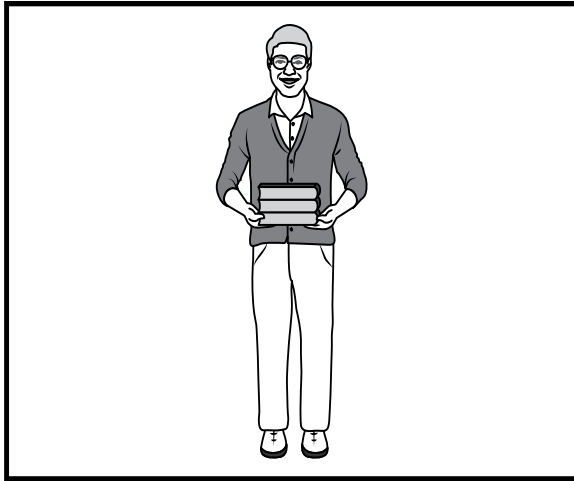

A. You can ask the librarian for help.



B. You can read in quiet places in the library.

Session 3 – Item 33 Answer Options



A. You can walk around the library.

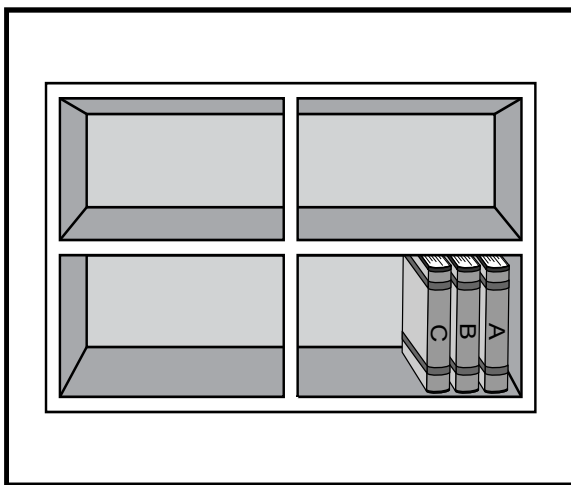

B. You can tell the librarian the author's name and the title of the book.

Session 3 – Item 35 Answer Options



A. In conclusion, books are sold in stores.

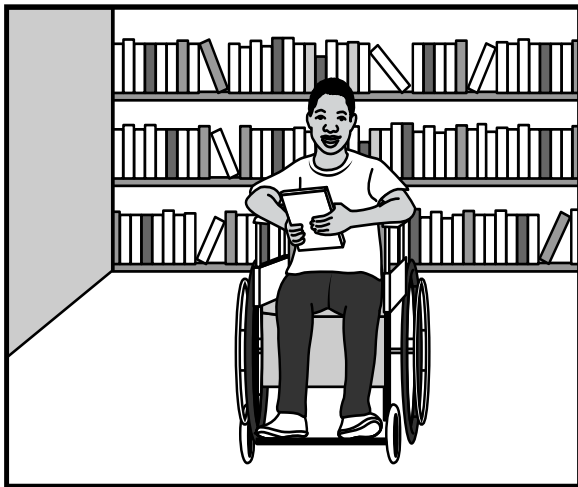

B. In conclusion, there are many ways to find a book in the library.

Session 4

Grade 8 Stimulus Materials List: After-school Activity

Card 1a: Graphic Organizer Problem/Solution

Card 2a: look on the school website

Card 3a: ask a friend

Card 4a: Hannah loves to listen to silly stories when it's raining.

Card 5a: Capital letters, end punctuation, complete sentences

Cards 6a and 7a: Response Template

Topic: After-school Activity

Problem:

You want to find an after-school activity, but you do not know what is available.

Details:

1)

2)

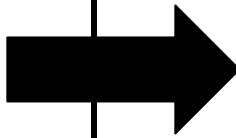

Solution:

Details:

look on the school website

After-school Activity Card 2a

ask a friend

After-school Activity Card 3a

Hannah loves to listen to silly stories when it's raining.

After-school Activity Card 4a

Card intentionally left blank.

B b E e

. ! ?

Good writers use complete sentences.

This essay is about how to solve the
problem_____

In particular,

Also,

To solve the problem,

In conclusion, to solve the problem _____

After-school Activity Card 7a

LEAP
CONNECT
Practice Test